

## TO-92 Plastic-Encapsulate Transistors

### KTC3203 TRANSISTOR (NPN)

#### FEATURES

- Complementary to KTA1271

#### MAXIMUM RATINGS (T<sub>a</sub>=25°C unless otherwise noted)

Symbol	Parameter	Value	Unit
V <sub>CB0</sub>	Collector-Base Voltage	35	V
V <sub>CEO</sub>	Collector-Emitter Voltage	30	V
V <sub>EBO</sub>	Emitter-Base Voltage	5	V
I <sub>C</sub>	Collector Current -Continuous	800	mA
P <sub>C</sub>	Collector Power Dissipation	625	mW
T <sub>J</sub>	Junction Temperature	150	°C
T <sub>stg</sub>	Storage Temperature	-55-150	°C

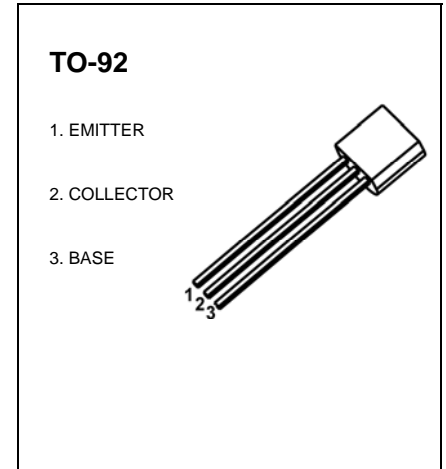

#### ELECTRICAL CHARACTERISTICS (T<sub>a</sub>=25°C unless otherwise specified)

Parameter	Symbol	Test conditions	Min	Typ	Max	Unit
Collector-base breakdown voltage	V <sub>(BR)CBO</sub>	I <sub>C</sub> = 0.1mA, I <sub>B</sub> =0	35			V
Collector-emitter breakdown voltage	V <sub>(BR)CEO</sub>	I <sub>C</sub> = 10mA, I <sub>B</sub> =0	30			V
Emitter-base breakdown voltage	V <sub>(BR)EBO</sub>	I <sub>E</sub> = 0.1mA, I <sub>C</sub> =0	5			V
Collector cut-off current	I <sub>CB0</sub>	V <sub>CB</sub> = 35V , I <sub>E</sub> =0			0.1	μA
Collector cut-off current	I <sub>CEO</sub>	V <sub>CE</sub> = 25V , I <sub>B</sub> =0			0.2	μA
Emitter cut-off current	I <sub>EBO</sub>	V <sub>EB</sub> = 5V, I <sub>C</sub> =0			0.1	μA
DC current gain	h <sub>FE(1)</sub>	V <sub>CE</sub> =1V, I <sub>C</sub> = 100mA	100		320	
	h <sub>FE(2)</sub>	V <sub>CE</sub> =1V, I <sub>C</sub> = 700mA	35			
Collector-emitter saturation voltage	V <sub>CE(sat)</sub>	I <sub>C</sub> = 500 mA, I <sub>B</sub> = 20mA			0.5	V
Base-emitter voltage	V <sub>BE</sub>	V <sub>CE</sub> = 1V, I <sub>C</sub> = 10mA			0.8	V
Transition frequency	f <sub>T</sub>	V <sub>CE</sub> = 5 V, I <sub>C</sub> = 10mA		120		MHz
Collector Output Capacitance	C <sub>ob</sub>	V <sub>CB</sub> =10V, I <sub>E</sub> = 0, f=1MHz		13		pF

#### CLASSIFICATION OF h<sub>FE(1)</sub>

Rank	O	Y
Range	100-200	160-320

# Typical Characteristics

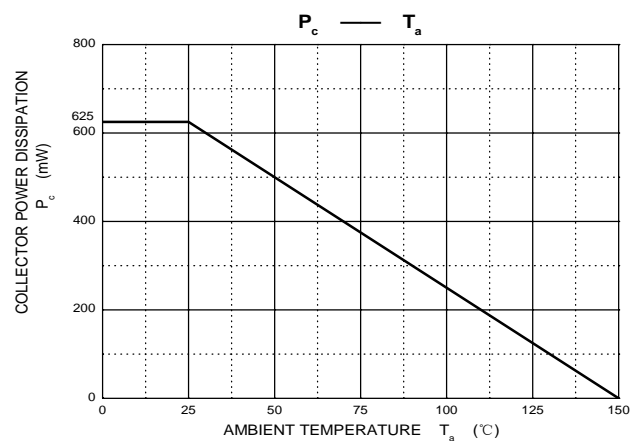
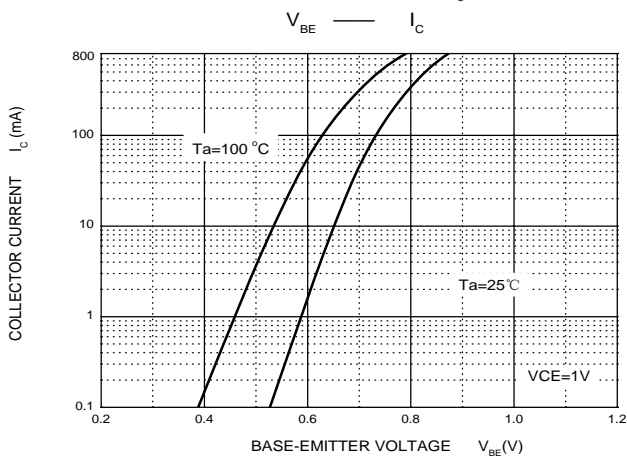
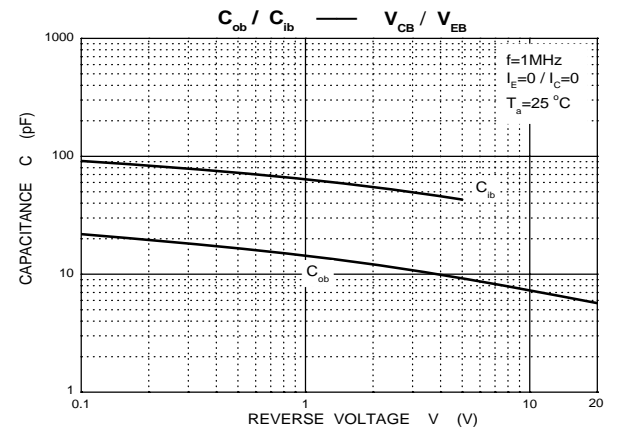
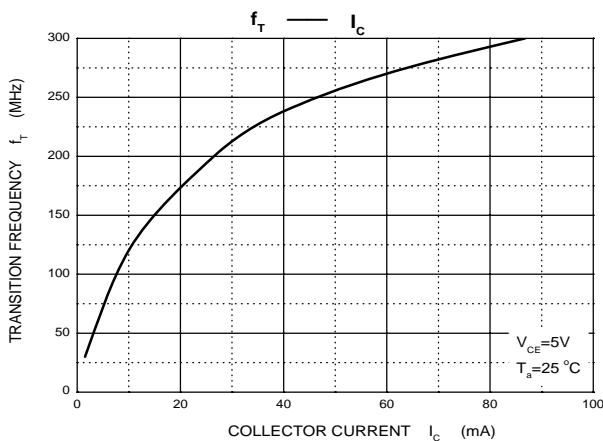
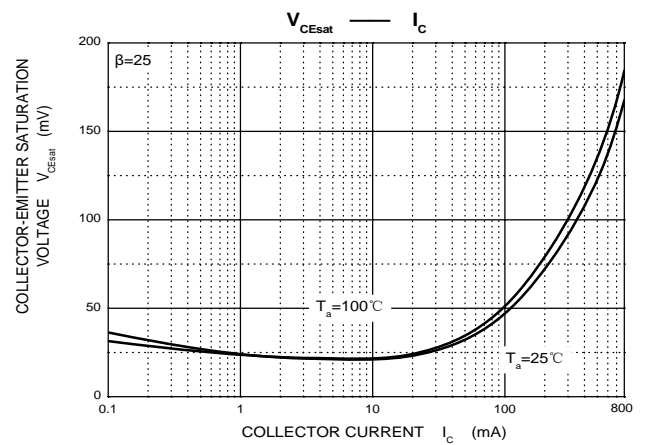
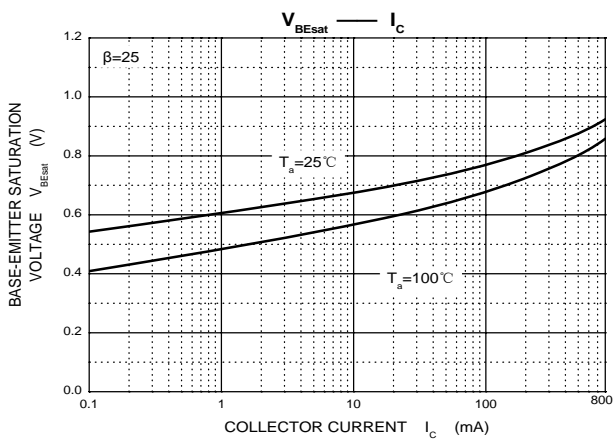
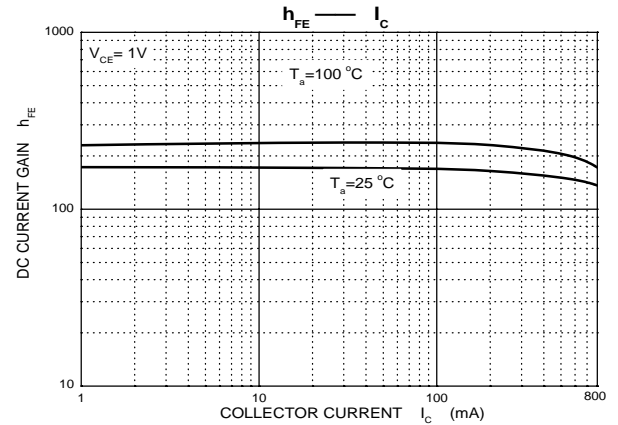
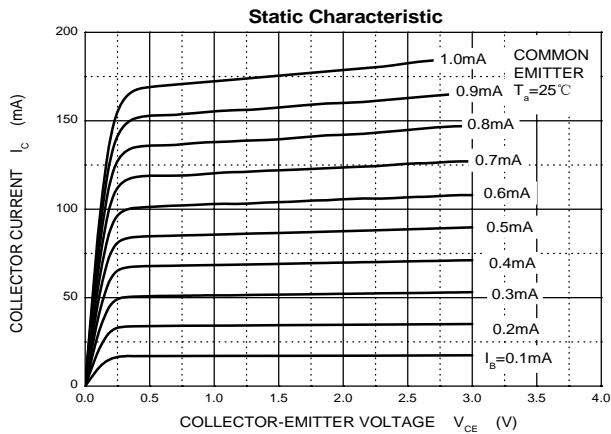

## TO-92 Package Outline Dimensions



Symbol	Dimensions In Millimeters		Dimensions In Inches	
	Min	Max	Min	Max
A	3.300	3.700	0.130	0.146
A1	1.100	1.400	0.043	0.055
b	0.380	0.550	0.015	0.022
c	0.360	0.510	0.014	0.020
D	4.300	4.700	0.169	0.185
D1	3.430		0.135	
E	4.300	4.700	0.169	0.185
e	1.270 TYP		0.050 TYP	
e1	2.440	2.640	0.096	0.104
L	14.100	14.500	0.555	0.571
Φ		1.600		0.063
h	0.000	0.380	0.000	0.015

## TO-92 Suggested Pad Layout



### Note:

1. Controlling dimension: in millimeters.
2. General tolerance:  $\pm 0.05\text{mm}$ .
3. The pad layout is for reference purposes only.

### NOTICE

JCET reserve the right to make modifications, enhancements, improvements, corrections or other changes without further notice to any product herein. JCET does not assume any liability arising out of the application or use of any product described herein.

TO-92 PACKAGE TAPEING DIMENSION



Dimiensions are in millimeter								
A1	A	T	P	P0	P2	F1	F2	W
4.5	4.5	3.5	12.7	12.7	6.35	2.5	2.5	18.0
W0	W1	W2	H	H0	D0	t1	t2	ΔP
6.0	9.0	1.0 MAX.	19.0	16.0	4.0	0.4	0.2	0



Package	Box	Box Size(mm)	Carton	Carton Size(mm)
TO-92	2000 pcs	333×162×43	20,000 pcs	350×340×250