

TO-92L Plastic-Encapsulate Transistors

KSC2331 TRANSISTOR (NPN)

FEATURE

- Complement to KSA931
- High Collector-Base Voltage: $V_{CB0}=80V$
- Collector Current: $I_C=700mA$
- Collector Dissipation: $P_C=0.75W$

TO-92L

- 1.EMITTER
2.COLLECTOR
3.BASE

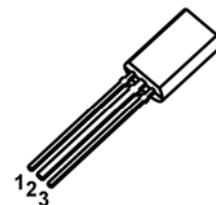

MARKING



C2331=Device code
Solid dot= Green molding compound device,
if none, the normal device
XXX=Code

Equivalent Circuit

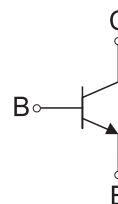

ORDERING INFORMATION

Part Number	Package	Packing Method	Pack Quantity
2SC2331	TO-92L	Bulk	500pcs/Bag
2SC2331-TA	TO-92L	Tape	2000pcs/Box

MAXIMUM RATINGS ($T_a=25^{\circ}C$ unless otherwise noted)

Symbol	Parameter	Value	Unit
V_{CB0}	Collector-Base Voltage	80	V
V_{CE0}	Collector-Emitter Voltage	60	V
V_{EB0}	Emitter-Base Voltage	8	V
I_C	Collector Current -Continuous	700	mA
P_C	Collector Power Dissipation	0.75	W
T_J	Junction Temperature	150	$^{\circ}C$
T_{stg}	Storage Temperature	-55-150	$^{\circ}C$

ELECTRICAL CHARACTERISTICS

$T_a=25^\circ\text{C}$ unless otherwise specified

Parameter	Symbol	Test conditions	Min	Typ	Max	Unit
Collector-base breakdown voltage	$V_{(BR)CBO}$	$I_C=100\mu\text{A}, I_E=0$	80			V
Collector-emitter breakdown voltage	$V_{(BR)CEO}$	$I_C=10\text{mA}, I_B=0$	60			V
Emitter-base breakdown voltage	$V_{(BR)EBO}$	$I_E=10\mu\text{A}, I_C=0$	8			V
Collector cut-off current	I_{CBO}	$V_{CB}=60\text{V}, I_E=0$			0.1	μA
Emitter cut-off current	I_{EBO}	$V_{EB}=5\text{V}, I_C=0$			0.1	μA
DC current gain	h_{FE}	$V_{CE}=2\text{V}, I_C=50\text{mA}$	40		240	
Collector-emitter saturation voltage	$V_{CE(sat)}$	$I_C=500\text{mA}, I_B=50\text{mA}$			0.7	V
Base-emitter voltage	$V_{BE(sat)}$	$I_C=500\text{mA}, I_B=50\text{mA}$			1.2	V
Collector output capacitance	C_{ob}	$V_{CB}=10\text{V}, I_E=0, f=1\text{MHz}$		8		pF
Transition frequency	f_T	$V_{CE}=10\text{V}, I_C=50\text{mA}$	30			MHz

CLASSIFICATION OF h_{FE}

Rank	R	O	Y
Range	40-80	70-140	120-240

TO-92L Package Outline Dimensions

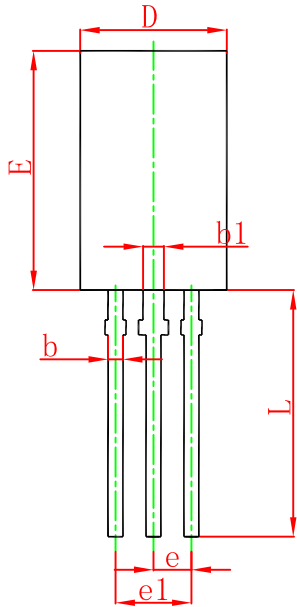
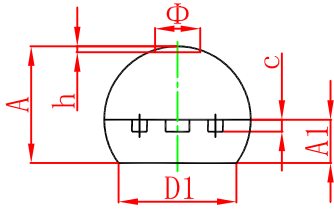

Symbol	Dimensions In Millimeters		Dimensions In Inches	
	Min.	Max.	Min.	Max.
A	3.750	4.050	0.148	0.159
A1	1.280	1.580	0.050	0.062
b	0.380	0.550	0.015	0.022
b1	0.620	0.780	0.024	0.031
c	0.350	0.450	0.014	0.018
D	4.750	5.050	0.187	0.199
D1	4.000		0.157	
E	7.850	8.150	0.309	0.321
e	1.270 TYP.		0.050 TYP.	
e1	2.440	2.640	0.096	0.104
L	13.800	14.200	0.543	0.559
Φ		1.600		0.063
h	0.000	0.300	0.000	0.012

TO-92L Suggested Pad Layout

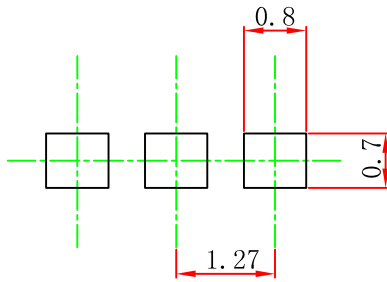

Note:

1. Controlling dimension: in millimeters.
2. General tolerance: ± 0.05 mm.
3. The pad layout is for reference purposes only.

NOTICE

JCET reserve the right to make modifications, enhancements, improvements, corrections or other changes without further notice to any product herein. JCET does not assume any liability arising out of the application or use of any product described herein.

TO-92L PACKAGE TAPEING DIMENSION

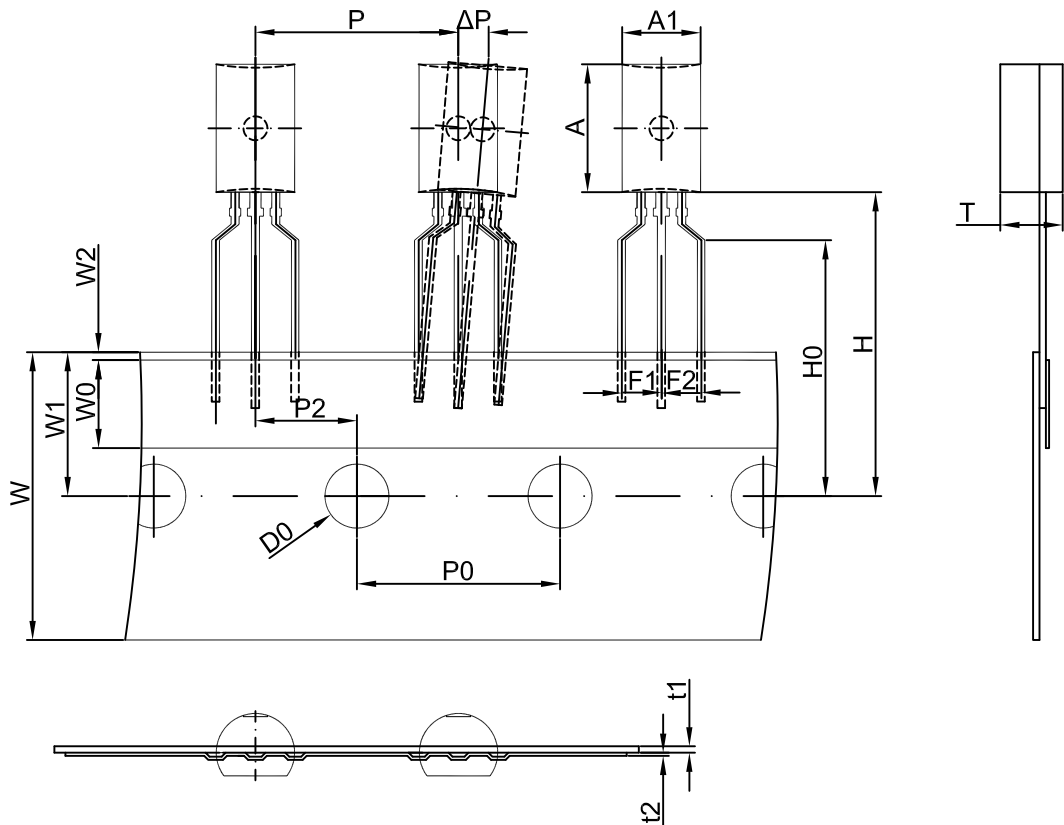

Dimensions are in millimeter

A1	A	T	P	P0	P2	F1	F2	W
4.9	8.0	3.9	12.7	12.7	6.35	2.5	2.5	18.0
W0	W1	W2	H	H0	D0	t1	t2	ΔP
6.0	9.0	1.0	19.0	16.0	4.0	0.4	0.2	0

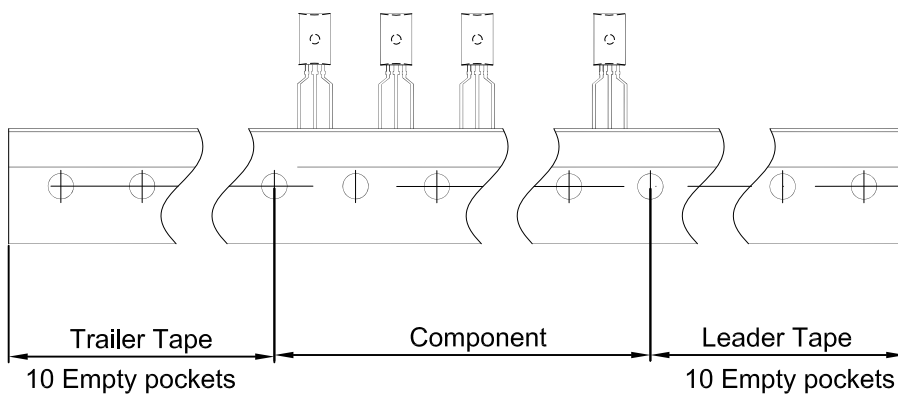

Package	Box	Box Size(mm)	Carton	Carton Size(mm)
TO-92L	2000 pcs	333×203×42	20,000 pcs	493×400×264