

TO-92MOD Plastic-Encapsulate Transistors

2SD667,2SD667A TRANSISTOR (NPN)

FEATURES

- Low Frequency Power Amplifier
- Complementary Pair with 2SB647/A

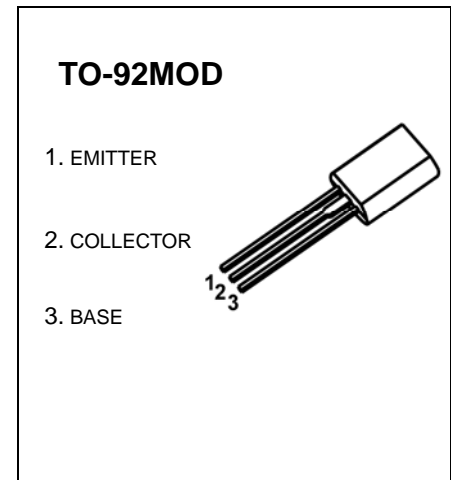

MARKING



D667=Device code
Solid dot= Green molding compound device,
if none, the normal device
XXX=Code



D667A=Device code
Solid dot= Green molding compound device,
if none, the normal device
XXX=Code

Equivalent Circuit

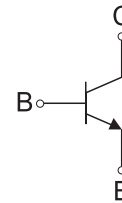

ORDERING INFORMATION

Part Number	Package	Packing Method	Pack Quantity
2SD667	TO-92MOD	Bulk	500pcs/Bag
2SD667-TA	TO-92MOD	Tape	2000pcs/Box
2SD667A	TO-92MOD	Bulk	500pcs/Bag
2SD667A-TA	TO-92MOD	Tape	2000pcs/Box

MAXIMUM RATINGS (T_a=25°C unless otherwise noted)

Symbol	Parameter	Value	Unit
V _{CB0}	Collector- Base Voltage	120	V
V _{CE0}	Collector-Emitter Voltage	2SD667	80
		2SD667A	100
V _{EB0}	Emitter-Base Voltage	5	V
I _c	Collector Current -Continuous	1	A
P _c	Collector Power Dissipation	900	mW
T _J	Junction Temperature	150	°C
T _{stg}	Storage Temperature	-55-150	°C

ELECTRICAL CHARACTERISTICS

$T_a=25^\circ\text{C}$ unless otherwise specified

Parameter	Symbol	Test conditions	Min	Typ	Max	Unit
Collector-base breakdown voltage	$V_{(BR)CBO}$	$I_C=10\mu\text{A}, I_E=0$	120			V
Collector-emitter breakdown voltage	$V_{(BR)CEO}$	$I_C=1\text{mA}, I_B=0$	2SD667	80		V
			2SD667A	100		V
Emitter-base breakdown voltage	$V_{(BR)EBO}$	$I_E=10\mu\text{A}, I_C=0$	5			V
Collector cut-off current	I_{CBO}	$V_{CB}=100\text{V}, I_E=0$			10	μA
Emitter cut-off current	I_{EBO}	$V_{EB}=4\text{V}, I_C=0$			10	μA
DC current gain	$h_{FE(1)}$	$V_{CE}=5\text{V}, I_C=150\text{mA}$	2SD667	60		320
			2SD667A	60		320
	$h_{FE(2)}$	$V_{CE}=5\text{V}, I_C=500\text{mA}$	30			
Collector-emitter saturation voltage	$V_{CE(sat)}$	$I_C=500\text{mA}, I_B=50\text{mA}$			1	V
Base-emitter voltage	V_{BE}	$V_{CE}=5\text{V}, I_C=150\text{mA}$			1.5	V
Transition frequency	f_T	$V_{CE}=5\text{V}, I_C=150\text{mA}$		140		MHz
Collector output capacitance	C_{ob}	$V_{CB}=10\text{V}, I_E=0, f=1\text{MHz}$		12		pF

CLASSIFICATION OF $h_{FE(1)}$

Rank		B	C	D
Range	2SD667	60-120	100-200	160-320
	2SD667A	60-120	100-200	160-320

Typical Characteristics

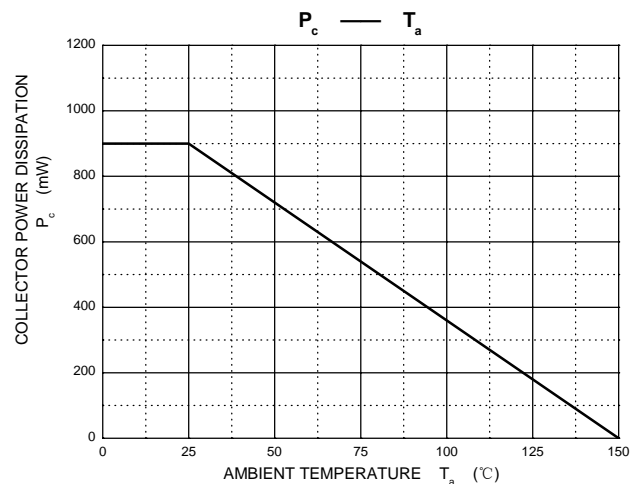
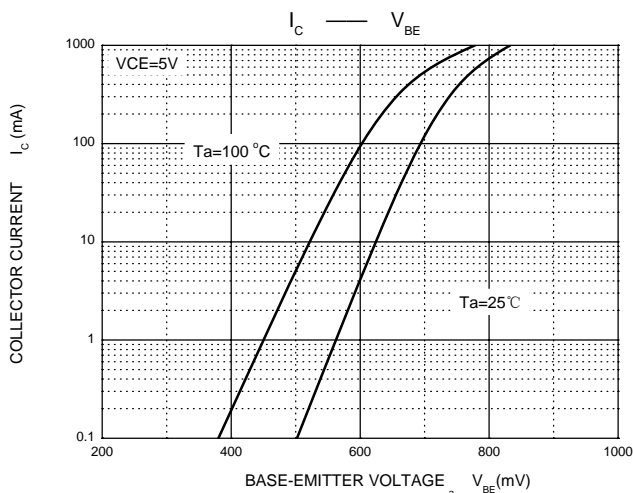
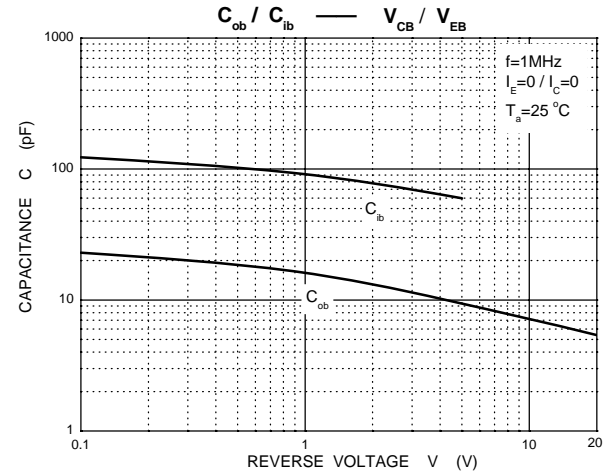
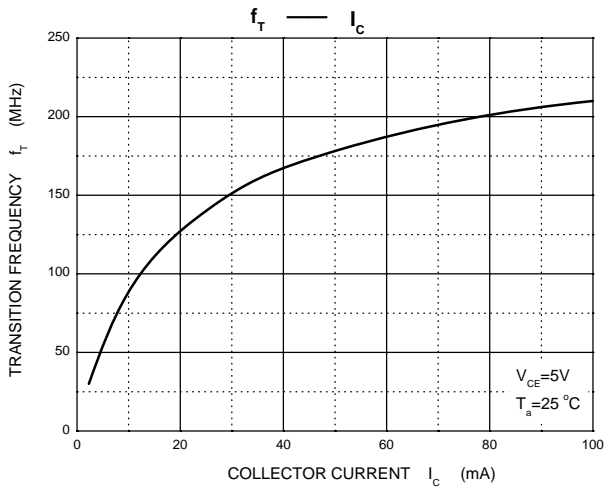
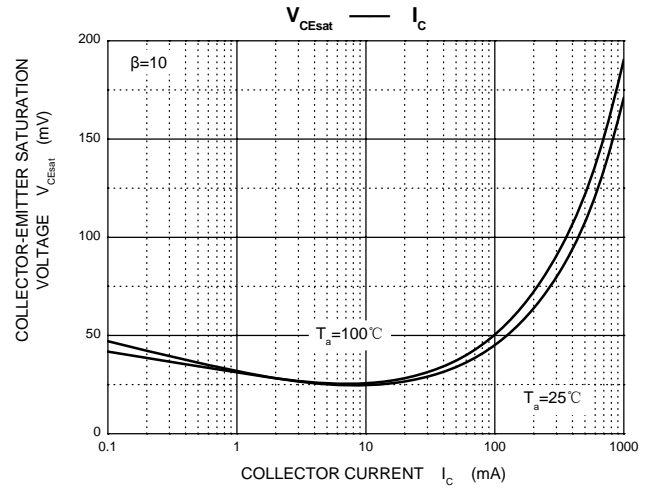
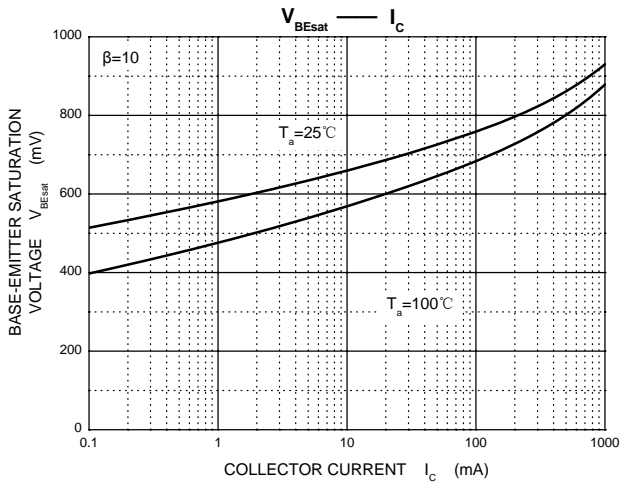
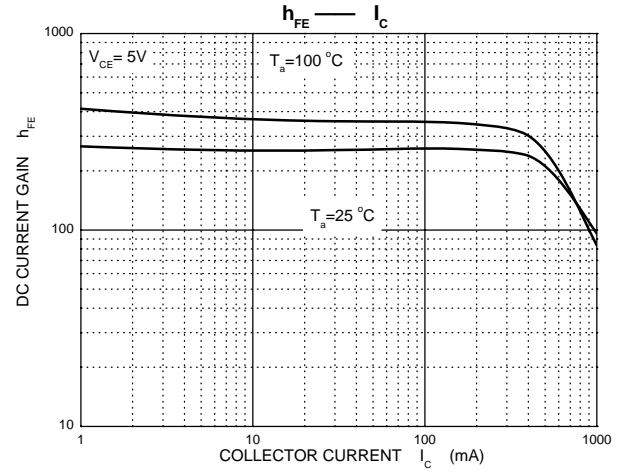
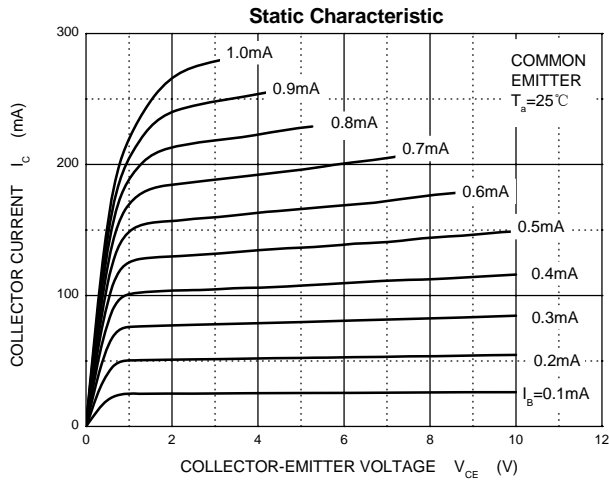

TO-92MOD Package Outline Dimensions

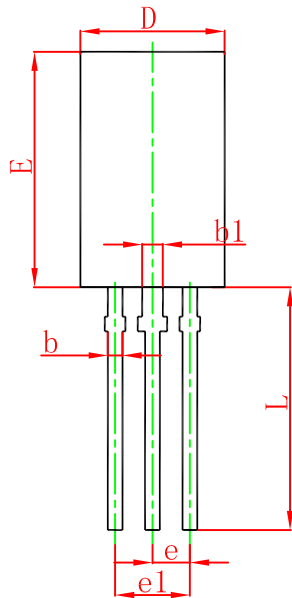
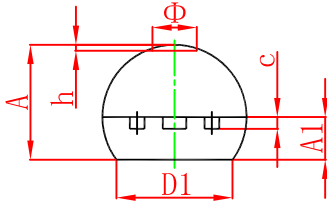

Symbol	Dimensions In Millimeters		Dimensions In Inches	
	Min.	Max.	Min.	Max.
A	4.800	5.000	0.189	0.197
A1	1.730	2.030	0.068	0.080
b	0.440	0.600	0.017	0.024
b1	0.940	1.100	0.037	0.043
c	0.350	0.450	0.014	0.018
D	5.900	6.100	0.232	0.240
D1	4.000		0.157	
E	8.500	8.700	0.335	0.343
e	1.500 TYP.		0.059 TYP.	
e1	2.900	3.100	0.114	0.122
L	13.800	14.200	0.543	0.559
Φ		1.600		0.063
h	0.000	0.380	0.000	0.015

TO-92MOD Suggested Pad Layout

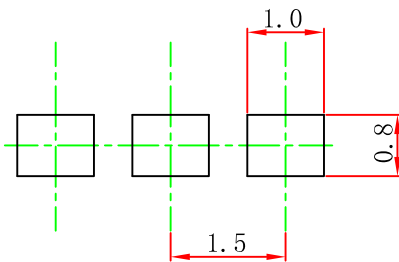

Note:

1. Controlling dimension: in millimeters.
2. General tolerance: ± 0.05 mm.
3. The pad layout is for reference purposes only.

NOTICE

JCET reserve the right to make modifications, enhancements, improvements, corrections or other changes without further notice to any product herein. JCET does not assume any liability arising out of the application or use of any product described herein.

TO-92MOD PACKAGE TAPEING DIMENSION

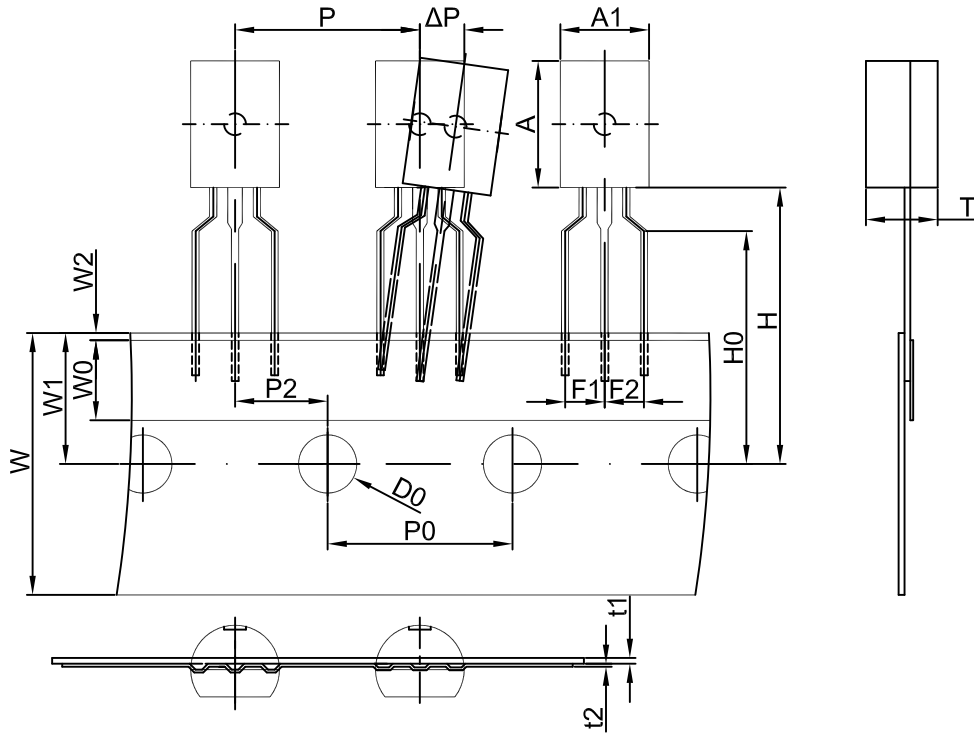

Dimensions are in millimeter

A1	A	T	P	P0	P2	F1	F2	W
6.0	8.6	4.9	12.7	12.7	6.35	2.5	2.5	18.0
W0	W1	W2	H	H0	D0	t1	t2	ΔP
6.0	9.0	1.0	19.0	16.0	4.0	0.4	0.2	0

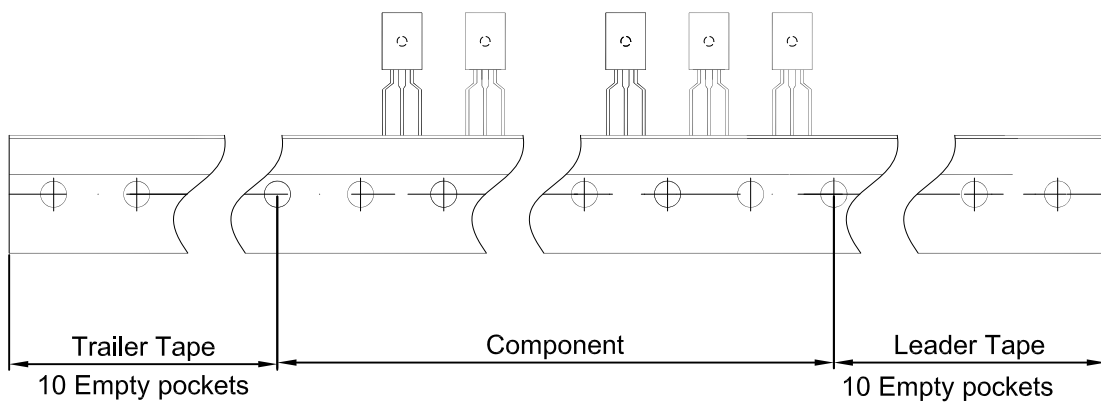

Package	Box	Box Size(mm)	Carton	Carton Size(mm)
TO-92MOD	2000 pcs	333×245×43	20,000 pcs	573×404×266