

## TO-126 Plastic-Encapsulate Transistors

### 2SD2136 TRANSISTOR (NPN)

#### FEATURES

- High Forward Current Transfer Ratio  $h_{FE}$  Which has Satisfactory Linearity.
- Low Collector-Emitter Saturation Voltage  $V_{CE(sat)}$
- Allowing Supply with the Radial Taping

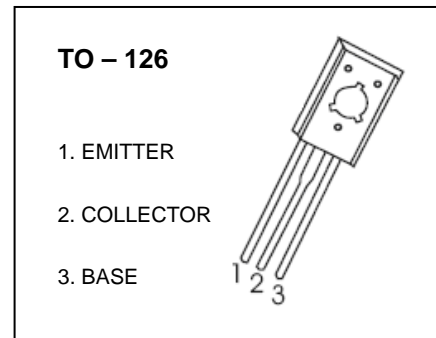

#### MARKING

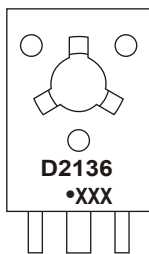

D2136=Device code  
Solid dot= Green molding compound device, if none, the normal device  
XXX=Code

#### Equivalent Circuit

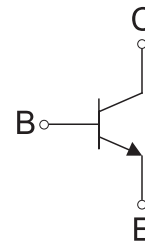

#### ORDERING INFORMATION

Part Number	Package	Packing Method	Pack Quantity
2SD2136	TO-126	Bulk	200pcs/Bag
2SD2136-TU	TO-126	Tube	60pcs/Tube

#### MAXIMUM RATINGS ( $T_a=25^{\circ}\text{C}$ unless otherwise noted)

Symbol	Parameter	Value	Unit
$V_{CBO}$	Collector-Base Voltage	60	V
$V_{CEO}$	Collector-Emitter Voltage	60	V
$V_{EBO}$	Emitter-Base Voltage	6	V
$I_C$	Collector Current	3	A
$P_C$	Collector Power Dissipation	1.25	W
$R_{\theta JA}$	Thermal Resistance From Junction To Ambient	100	$^{\circ}\text{C}/\text{W}$
$T_j$	Junction Temperature	150	$^{\circ}\text{C}$
$T_{stg}$	Storage Temperature	-55~+150	$^{\circ}\text{C}$

## ELECTRICAL CHARACTERISTICS

$T_a=25^\circ\text{C}$  unless otherwise specified

Parameter	Symbol	Test conditions	Min	Typ	Max	Unit
Collector-base breakdown voltage	$V_{(BR)CBO}$	$I_C=100\mu\text{A}, I_E=0$	60			V
Collector-emitter breakdown voltage	$V_{(BR)CEO}^*$	$I_C=30\text{mA}, I_B=0$	60			V
Emitter-base breakdown voltage	$V_{(BR)EBO}$	$I_E=100\mu\text{A}, I_C=0$	6			V
Collector cut-off current	$I_{CBO}$	$V_{CB}=60\text{V}, I_E=0$			200	$\mu\text{A}$
Collector cut-off current	$I_{CEO}$	$V_{CE}=60\text{V}, I_B=0$			300	$\mu\text{A}$
Emitter cut-off current	$I_{EBO}$	$V_{EB}=6\text{V}, I_C=0$			1	mA
DC current gain	$h_{FE(1)}^*$	$V_{CE}=4\text{V}, I_C=1\text{A}$	40		250	
	$h_{FE(2)}^*$	$V_{CE}=4\text{V}, I_C=3\text{A}$	10			
Collector-emitter saturation voltage	$V_{CE(sat)}^*$	$I_C=3\text{A}, I_B=0.375\text{A}$			1.2	V
Base-emitter voltage	$V_{BE}^*$	$V_{CE}=4\text{V}, I_C=3\text{A}$			1.8	V
Transition frequency	$f_T$	$V_{CE}=5\text{V}, I_C=0.1\text{A}, f=10\text{MHz}$		30		MHz

\*Pulse test: pulse width  $\leq 300\mu\text{s}$ , duty cycle  $\leq 2.0\%$ .

### CLASSIFICATION OF $h_{FE(1)}$

RANK	P	Q	R
RANGE	40-90	70-150	120-250

# Typical Characteristics

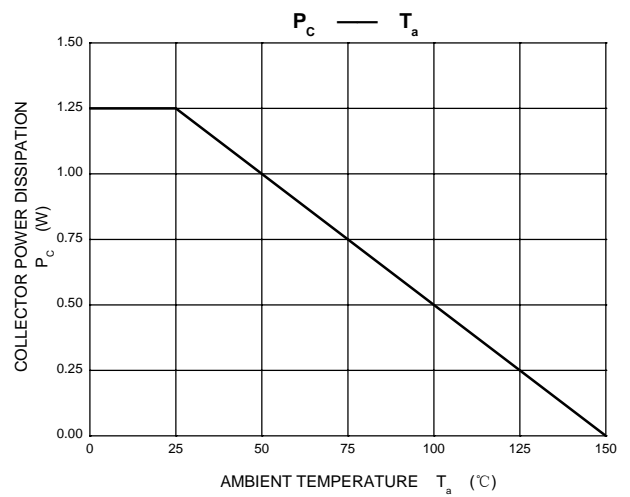
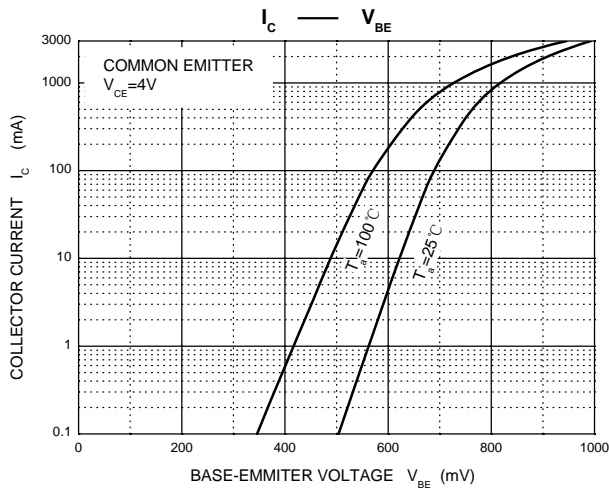
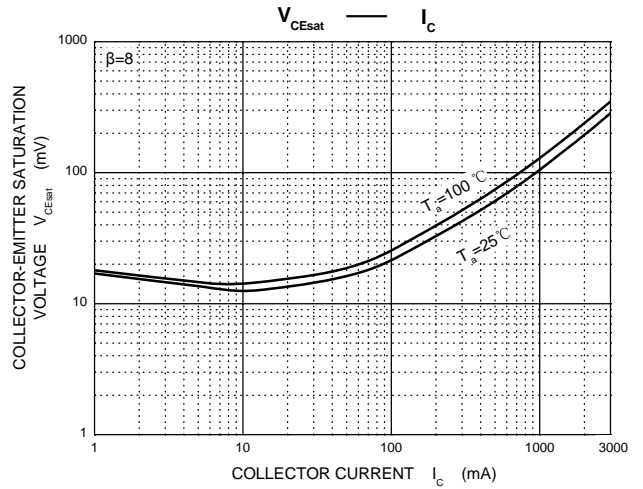
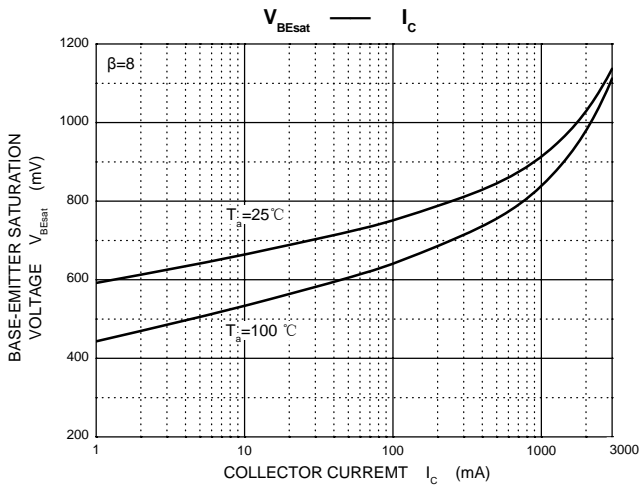
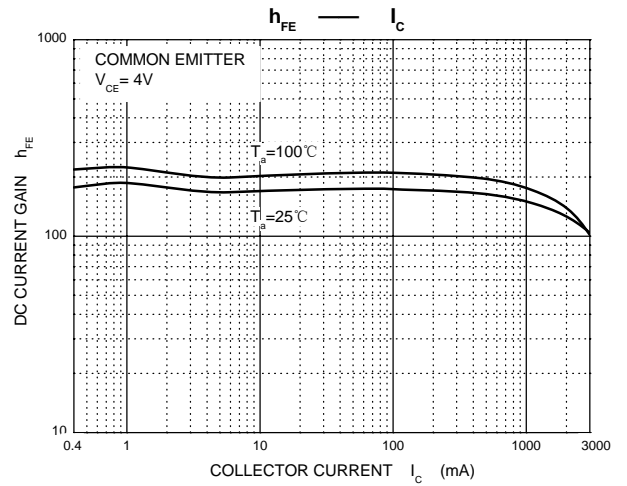
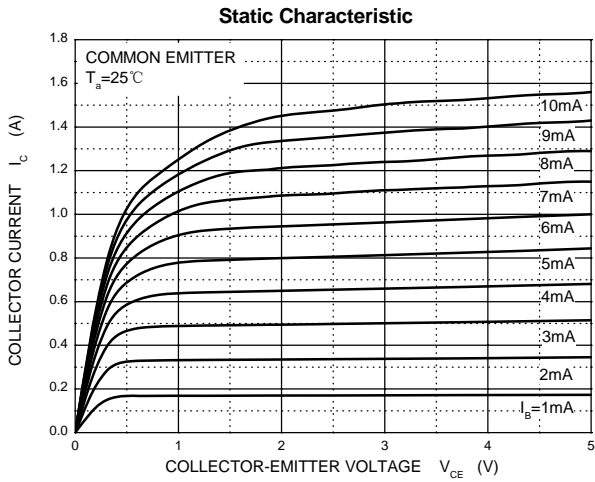

# TO-126 Package Outline Dimensions

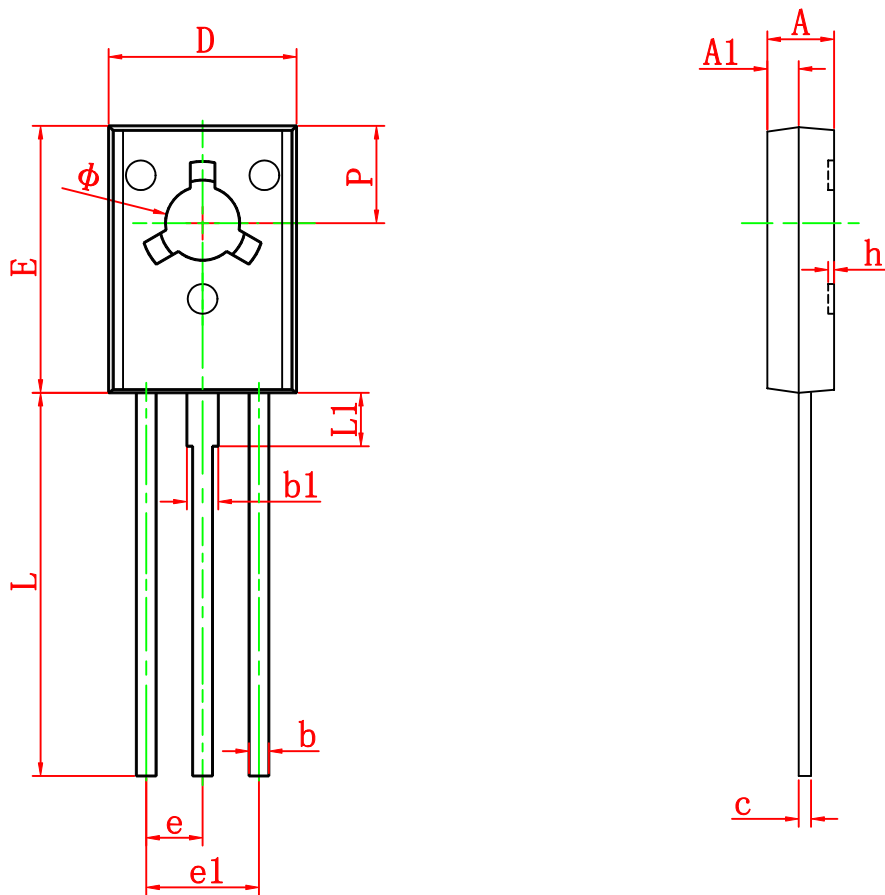

Symbol	Dimensions In Millimeters		Dimensions In Inches	
	Min	Max	Min	Max
A	2.500	2.900	0.098	0.114
A1	1.100	1.500	0.043	0.059
b	0.660	0.860	0.026	0.034
b1	1.170	1.370	0.046	0.054
c	0.450	0.600	0.018	0.024
D	7.400	7.800	0.291	0.307
E	10.600	11.000	0.417	0.433
e	2.290 TYP		0.090 TYP	
e1	4.480	4.680	0.176	0.184
h	0.000	0.300	0.000	0.012
L	15.300	15.700	0.602	0.618
L1	2.100	2.300	0.083	0.091
P	3.900	4.100	0.154	0.161
Φ	3.000	3.200	0.118	0.126