

TO-220F Plastic-Encapsulate Transistors

2SD2012 TRANSISTOR (NPN)

FEATURES

- Audio frequency power amplifier applications
- High DC current gain
- Low saturation voltage
- High power dissipation

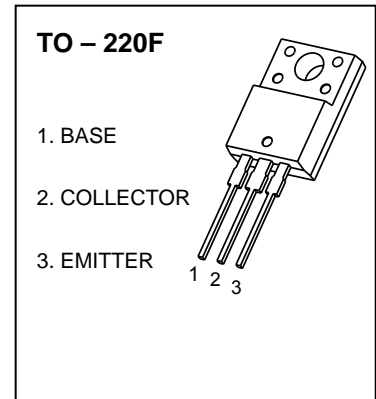

MAXIMUM RATINGS ($T_A=25^{\circ}\text{C}$ unless otherwise noted)

Symbol	Parameter	Value	Units
V_{CB0}	Collector-Base Voltage	60	V
V_{CEO}	Collector-Emitter Voltage	60	V
V_{EBO}	Emitter-Base Voltage	7	V
I_C	Collector Current -Continuous	3	A
P_C	Collector power dissipation	2	W
T_J	Junction Temperature	150	$^{\circ}\text{C}$
T_{stg}	Storage Temperature	-55-150	$^{\circ}\text{C}$

ELECTRICAL CHARACTERISTICS ($T_{amb}=25^{\circ}\text{C}$ unless otherwise specified)

Parameter	Symbol	Test conditions	MIN	TYP	MAX	UNIT
Collector-base breakdown voltage	$V_{(BR)CBO}$	$I_C=100\mu\text{A}$, $I_E=0$	60			V
Collector-emitter breakdown voltage	$V_{(BR)CEO}$	$I_C=50\text{mA}$, $I_B=0^{1)}$	60			V
Emitter-base breakdown voltage	$V_{(BR)EBO}$	$I_E=100\mu\text{A}$, $I_C=0$	7			V
Collector cut-off current	I_{CBO}	$V_{CB}=60\text{V}$, $I_E=0$			100	μA
Emitter cut-off current	I_{EBO}	$V_{EB}=7\text{V}$, $I_C=0$			100	μA
DC current gain	h_{FE1}	$V_{CE}=5\text{V}$, $I_C=0.5\text{A}$	100		320	
	h_{FE2}	$V_{CE}=5\text{V}$, $I_C=2\text{A}$	20			
Collector-emitter saturation voltage	$V_{CE(sat)}$	$I_C=2\text{A}$, $I_B=0.2\text{A}$			1	V
Base-emitter voltage	V_{BE}	$V_{CE}=5\text{V}$, $I_C=0.5\text{A}$			1	V
Transition frequency	f_T	$V_{CE}=5\text{V}$, $I_C=0.5\text{A}$		3		MHz
collector capacitance	C_{ob}	$V_{CB}=10\text{V}$, $I_E=0$, $f=1\text{MHz}$		35		pF

Typical Characteristics

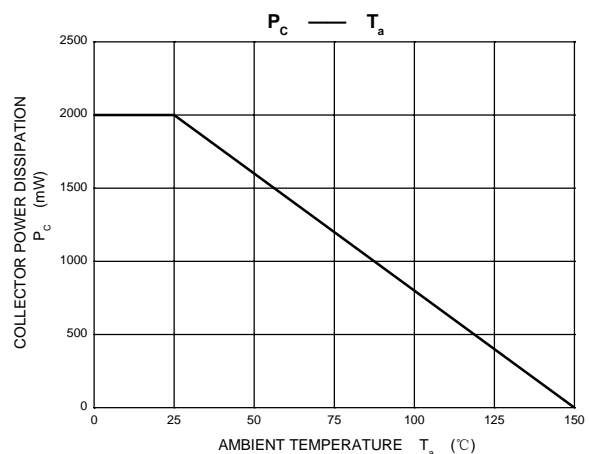
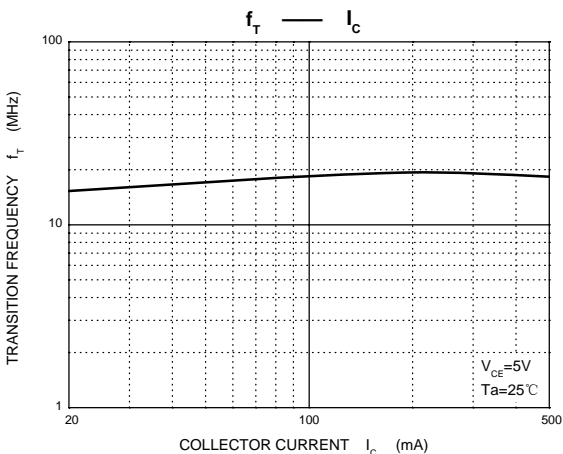
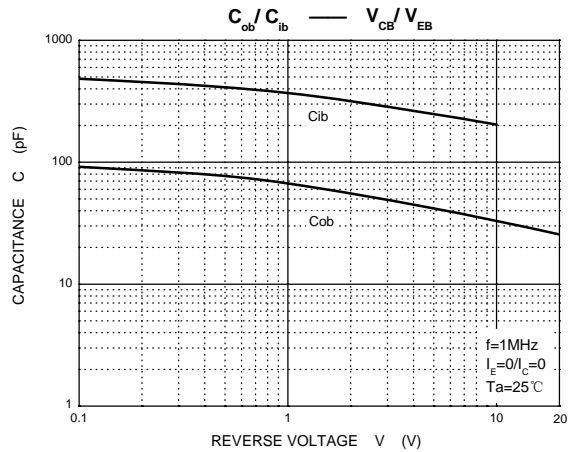
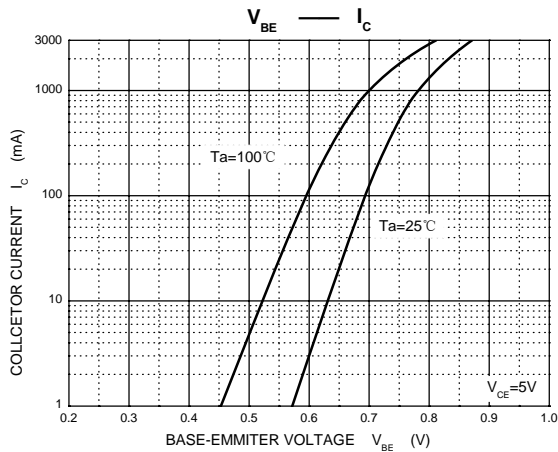
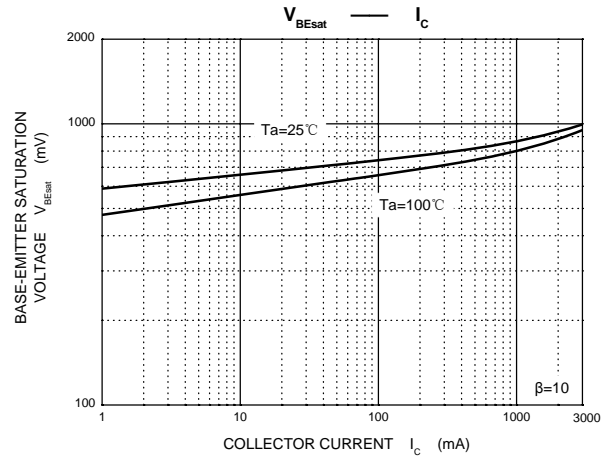
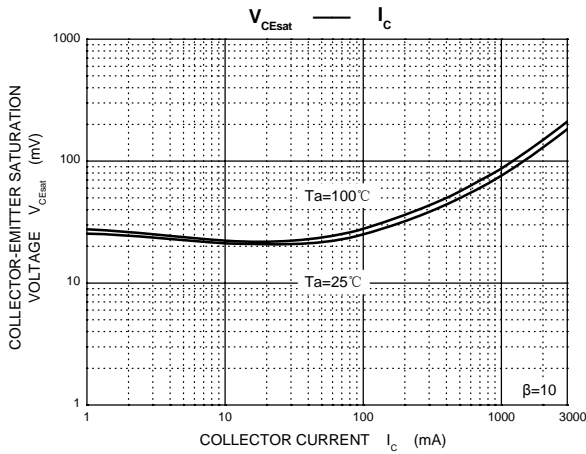
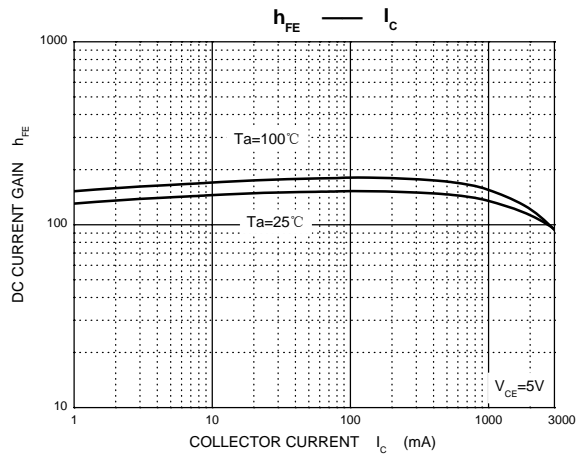
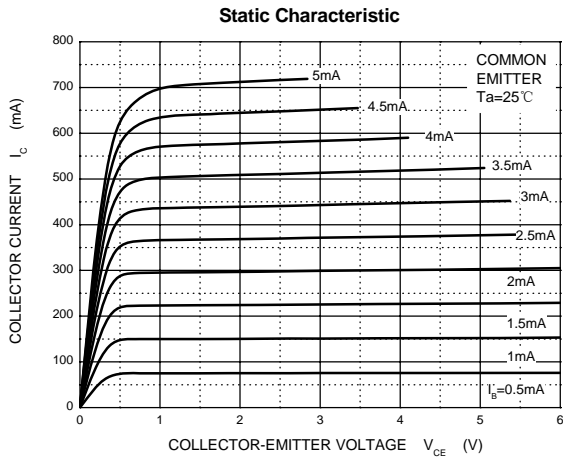

TO-220F Package Outline Dimensions

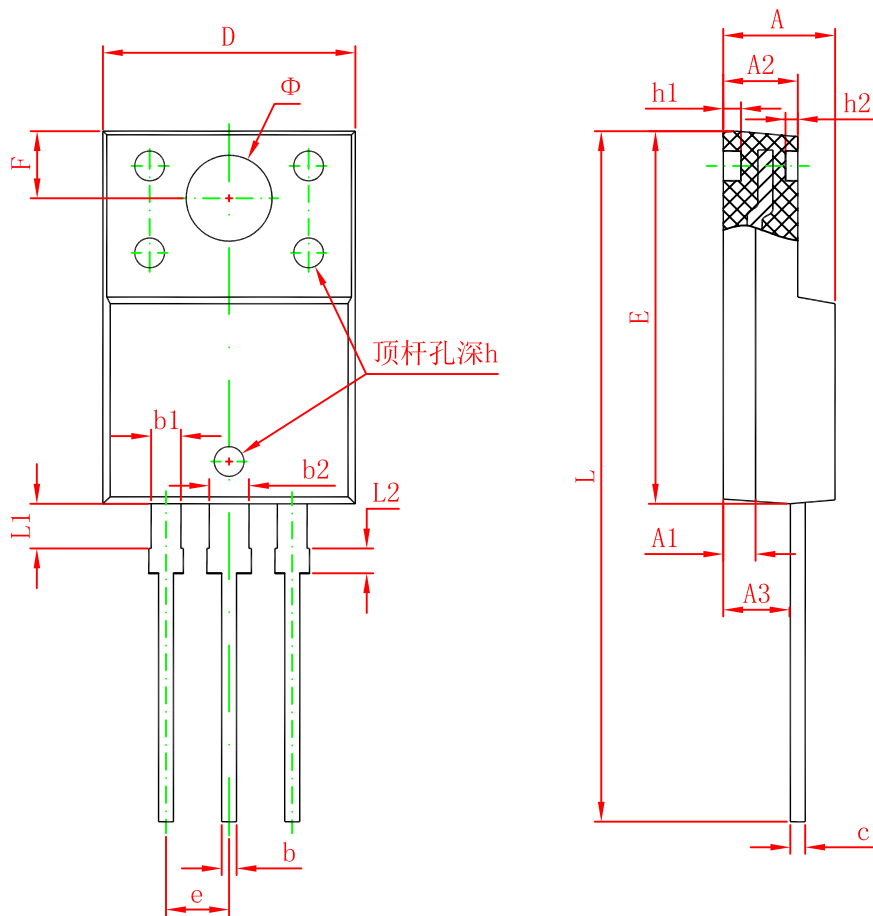

Symbol	Dimensions In Millimeters		Dimensions In Inches	
	Min.	Max.	Min.	Max.
A	4.300	4.700	0.169	0.185
A1	1.300 REF.		0.051 REF.	
A2	2.800	3.200	0.110	0.126
A3	2.500	2.900	0.098	0.114
b	0.500	0.750	0.020	0.030
b1	1.100	1.350	0.043	0.053
b2	1.500	1.750	0.059	0.069
c	0.500	0.750	0.020	0.030
D	9.960	10.360	0.392	0.408
E	14.800	15.200	0.583	0.598
e	2.540 TYP.		0.100 TYP.	
F	2.700 REF.		0.106 REF.	
Φ	3.500 REF.		0.138 REF.	
h	0.000	0.300	0.000	0.012
h1	0.800 REF.		0.031 REF.	
h2	0.500 REF.		0.020 REF.	
L	28.000	28.400	1.102	1.118
L1	1.700	1.900	0.067	0.075
L2	0.900	1.100	0.035	0.043