

## TO-92MOD Plastic-Encapsulate Transistors

### 2SC2236 TRANSISTOR (NPN)

#### FEATURE



Complementary to 2SA966 and 3 Watts output Applications.

#### TO-92MOD

1. EMITTER
2. COLLECTOR
3. BASE

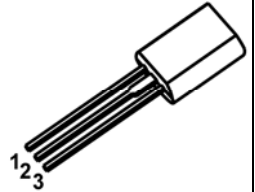

#### MARKING

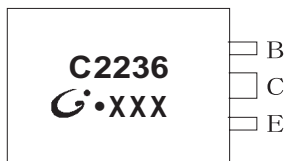

C2236=Device code  
 Solid dot= Green molding compound device,  
 if none, the normal device  
 XXX=Code

#### Equivalent Circuit

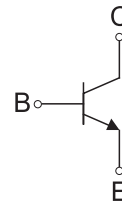

#### ORDERING INFORMATION

Part Number	Package	Packing Method	Pack Quantity
2SC2236	TO-92MOD	Bulk	500pcs/Bag
2SC2236-TA	TO-92MOD	Tape	2000pcs/Box

#### MAXIMUM RATINGS (T<sub>a</sub>=25 °C unless otherwise noted)

Symbol	Parameter	Value	Unit
V <sub>CB0</sub>	Collector-Base Voltage	30	V
V <sub>CE0</sub>	Collector-Emitter Voltage	30	V
V <sub>EB0</sub>	Emitter-Base Voltage	5	V
I <sub>c</sub>	Collector Current -Continuous	1.5	A
P <sub>c</sub>	Collector Power Dissipation	0.9	W
T <sub>J</sub>	Junction Temperature	150	°C
T <sub>stg</sub>	Storage Temperature	-55 to +150	°C

## ELECTRICAL CHARACTERISTICS

$T_a=25^\circ\text{C}$  unless otherwise specified

Parameter	Symbol	Test conditions	Min	Typ	Max	Unit
Collector-base breakdown voltage	$V_{(BR)CBO}$	$I_C=1\text{mA}, I_E=0$	30			V
Collector-emitter breakdown voltage	$V_{(BR)CEO}$	$I_C=10\text{mA}, I_B=0$	30			V
Emitter-base breakdown voltage	$V_{(BR)EBO}$	$I_E=1\text{mA}, I_C=0$	5			V
Collector cut-off current	$I_{CBO}$	$V_{CB}=30\text{V}, I_E=0$			0.1	$\mu\text{A}$
Emitter cut-off current	$I_{EBO}$	$V_{EB}=5\text{V}, I_C=0$			0.1	$\mu\text{A}$
DC current gain	$h_{FE}$	$V_{CE}=2\text{V}, I_C=500\text{mA}$	100		320	
Collector-emitter saturation voltage	$V_{CE(sat)}$	$I_C=1.5\text{A}, I_B=0.03\text{A}$			2	V
Base-emitter voltage	$V_{BE}$	$I_C=500\text{mA}, V_{CE}=2\text{V}$			1	V
Transition frequency	$f_T$	$V_{CE}=2\text{V}, I_C=500\text{mA}$		120		MHz
Collector output Capacitance	$C_{ob}$	$V_{CB}=10\text{V}, I_E=0, f=1\text{MHz}$			30	pF

### CLASSIFICATION OF $h_{FE}$

Rank	O	Y
Range	100-200	160-320

# Typical Characteristics

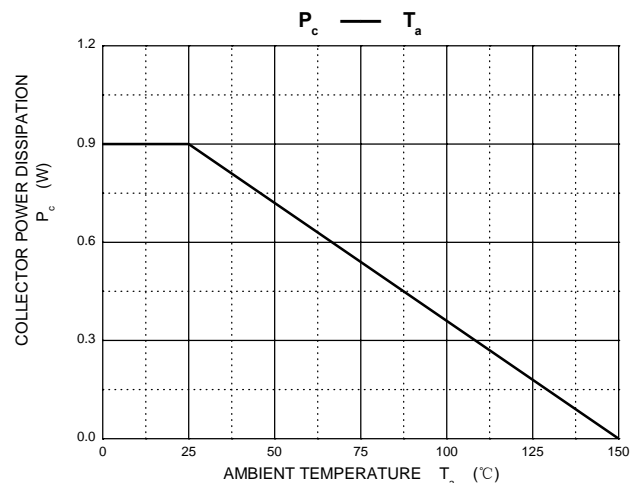
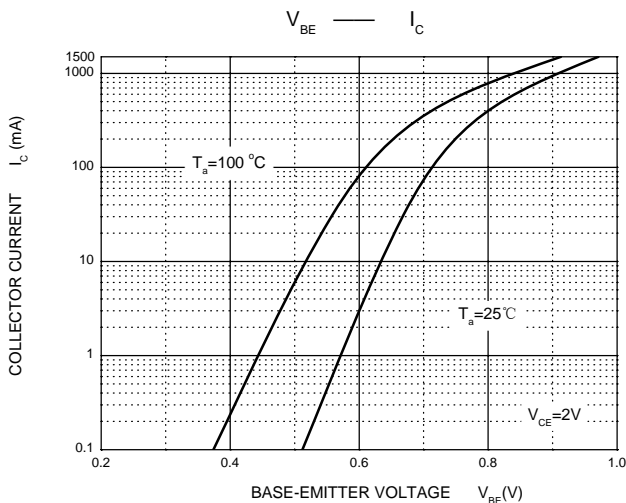
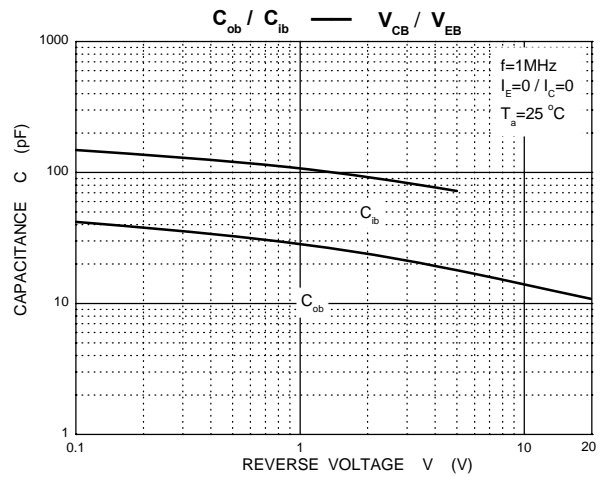
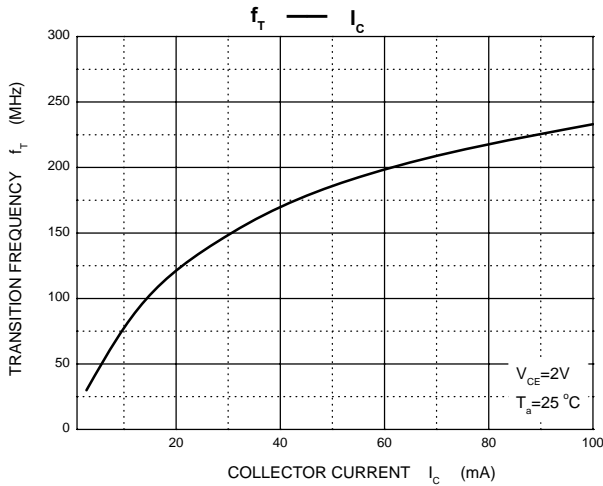
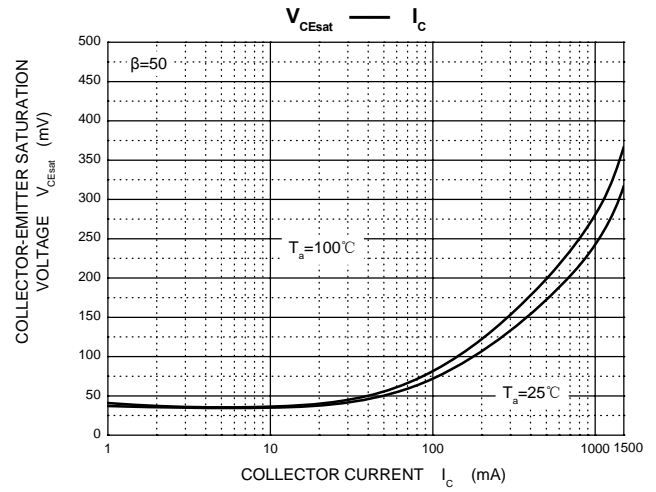
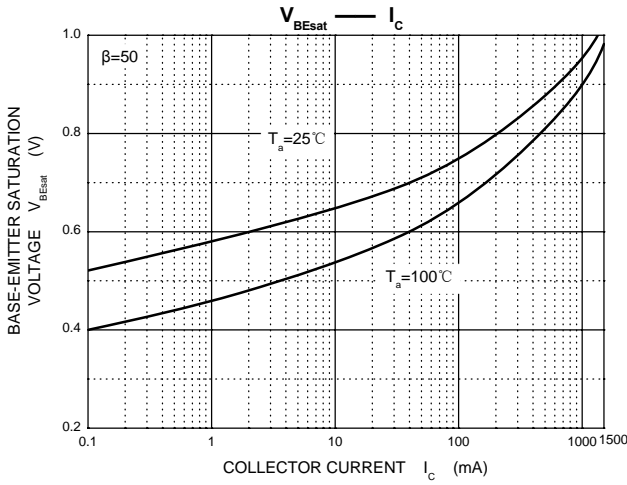
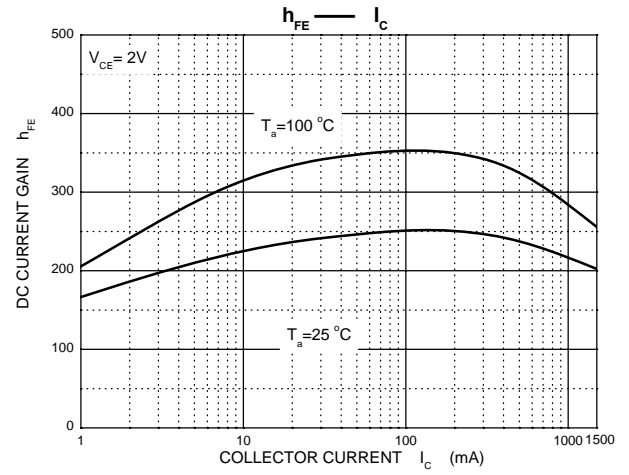
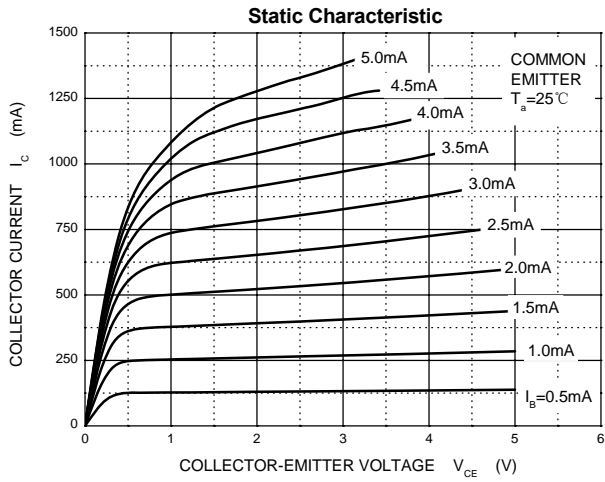

## TO-92MOD Package Outline Dimensions

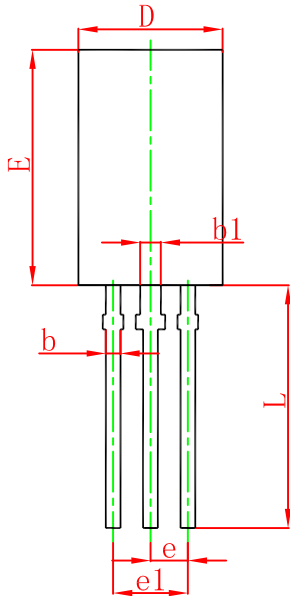
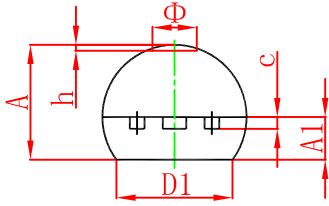

Symbol	Dimensions In Millimeters		Dimensions In Inches	
	Min.	Max.	Min.	Max.
A	4.800	5.000	0.189	0.197
A1	1.730	2.030	0.068	0.080
b	0.440	0.600	0.017	0.024
b1	0.940	1.100	0.037	0.043
c	0.350	0.450	0.014	0.018
D	5.900	6.100	0.232	0.240
D1	4.000		0.157	
E	8.500	8.700	0.335	0.343
e	1.500 TYP.		0.059 TYP.	
e1	2.900	3.100	0.114	0.122
L	13.800	14.200	0.543	0.559
$\Phi$		1.600		0.063
h	0.000	0.380	0.000	0.015

## TO-92MOD Suggested Pad Layout

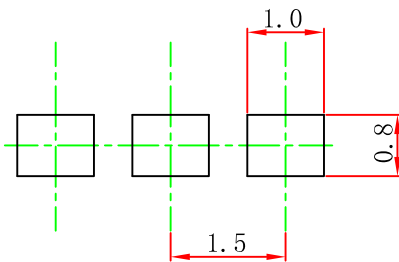

Note:

1. Controlling dimension: in millimeters.
2. General tolerance:  $\pm 0.05$ mm.
3. The pad layout is for reference purposes only.

### NOTICE

JCET reserve the right to make modifications, enhancements, improvements, corrections or other changes without further notice to any product herein. JCET does not assume any liability arising out of the application or use of any product described herein.

# TO-92MOD PACKAGE TAPEING DIMENSION

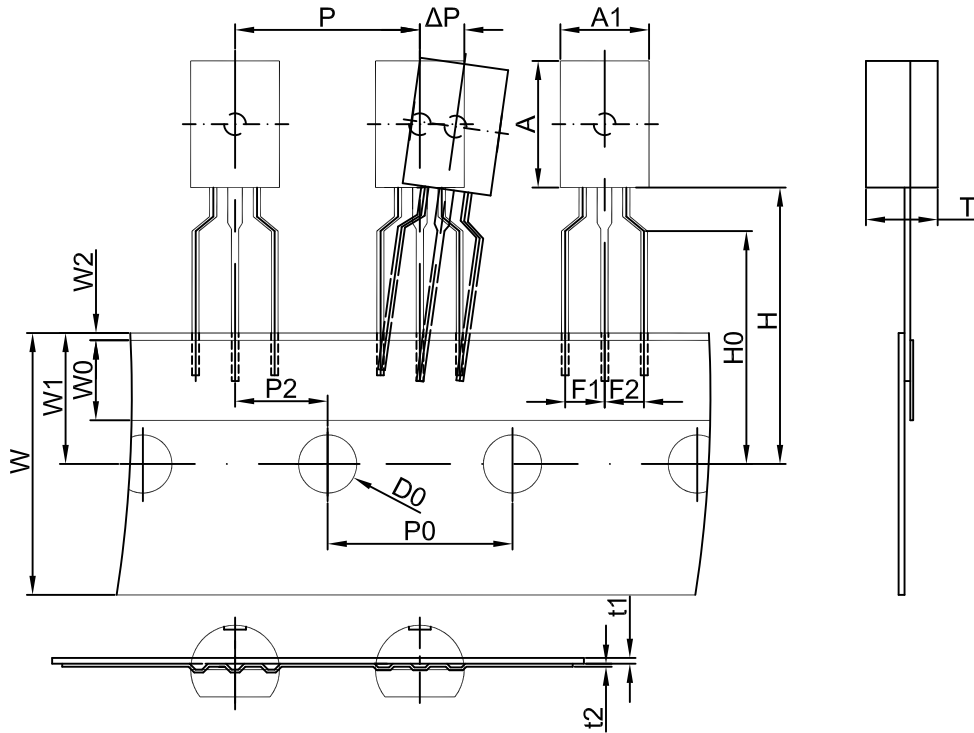

Dimensions are in millimeter

A1	A	T	P	P0	P2	F1	F2	W
6.0	8.6	4.9	12.7	12.7	6.35	2.5	2.5	18.0
W0	W1	W2	H	H0	D0	t1	t2	ΔP
6.0	9.0	1.0	19.0	16.0	4.0	0.4	0.2	0

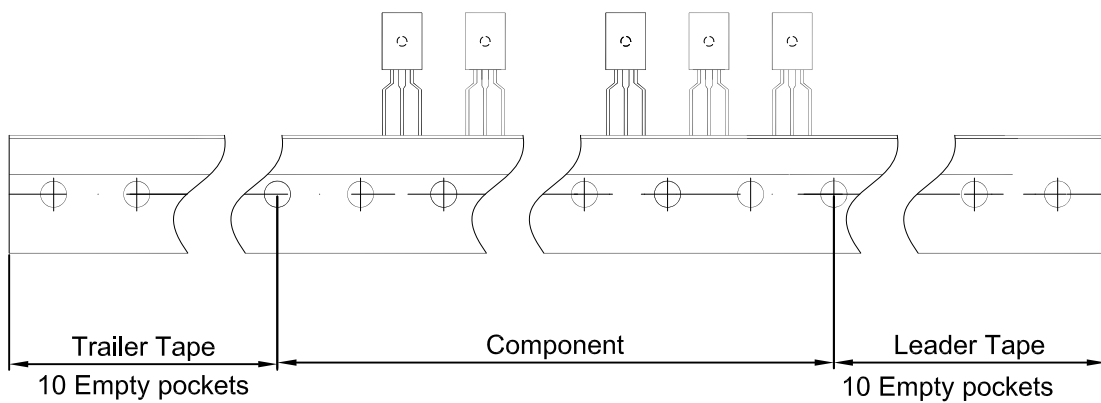

Package	Box	Box Size(mm)	Carton	Carton Size(mm)
TO-92MOD	2000 pcs	333×245×43	20,000 pcs	573×404×266