

TO-92MOD Plastic-Encapsulate Transistors

2SC2235 TRANSISTOR (NPN)

FEATURES

Complementary to 2SA965

MAXIMUM RATINGS ($T_a=25^{\circ}\text{C}$ unless otherwise noted)

Symbol	Parameter	Value	Unit
V_{CB0}	Collector-Base Voltage	120	V
V_{CE0}	Collector-Emitter Voltage	120	V
V_{EB0}	Emitter-Base Voltage	5	V
I_C	Collector Current -Continuous	0.8	A
P_C	Collector Power Dissipation	0.9	W
T_J	Junction Temperature	150	$^{\circ}\text{C}$
T_{stg}	Storage Temperature	-55to+150	$^{\circ}\text{C}$

TO-92MOD

1. EMITTER
2. COLLECTER
3. BASE

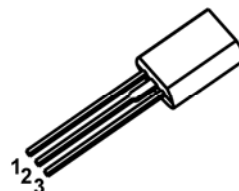

ELECTRICAL CHARACTERISTICS ($T_a=25^{\circ}\text{C}$ unless otherwise specified)

Parameter	Symbol	Test conditions	Min	Typ	Max	Unit
Collector-base breakdown voltage	$V_{(BR)CBO}$	$I_C=1\text{mA}, I_E=0$	120			V
Collector-emitter breakdown voltage	$V_{(BR)CEO}$	$I_C=10\text{mA}, I_B=0$	120			V
Emitter-Base breakdown voltage	$V_{(BR)EBO}$	$I_E=1\text{mA}, I_C=0.5$				V
Collector cut-off current	I_{CBO}	$V_{CB}=120\text{V}, I_E=0$			0.1	μA
Emitter cut-off current	I_{EBO}	$V_{EB}=5\text{V}, I_C=0$			0.1	μA
DC current gain	h_{FE}	$V_{CE}=5\text{V}, I_C=100\text{mA}$	80		240	
Collector-emitter saturation voltage	$V_{CE(sat)}$	$I_C=500\text{mA}, I_B=50\text{mA}$			1.0	V
Base-emitter voltage	V_{BE}	$I_C=500\text{mA}, V_{CE}=5\text{V}$			1.0	V
Transition frequency	f_T	$V_{CE}=5\text{V}, I_C=100\text{mA}$		120		MHz
Collector output capacitance	C_{ob}	$V_{CB}=10\text{V}, I_E=0$ $f=1\text{MHz}$			30	pF

CLASSIFICATION OF h_{FE}

Rank	O	Y
Range	80-160	120-240

Typical Characteristics

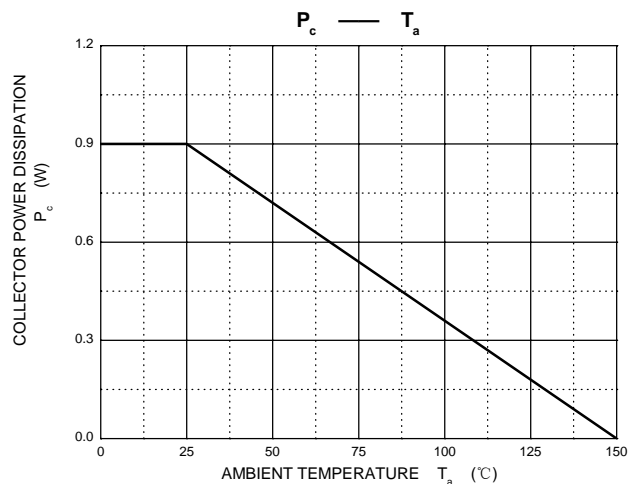
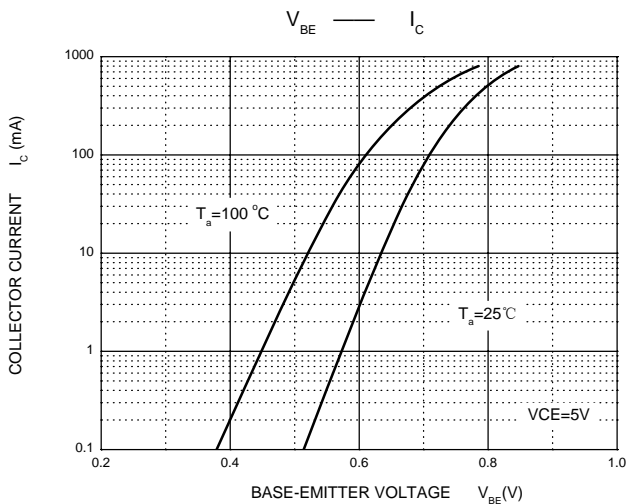
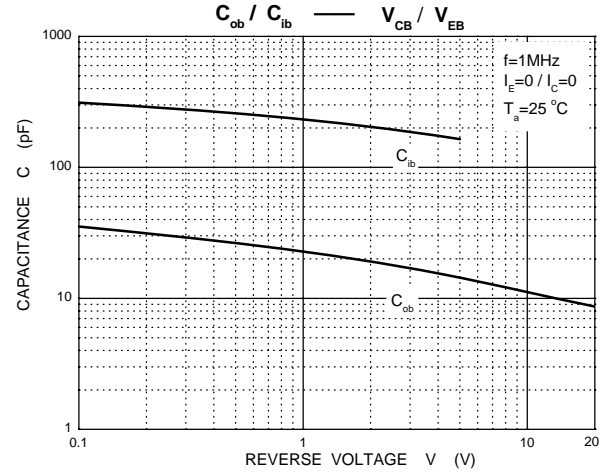
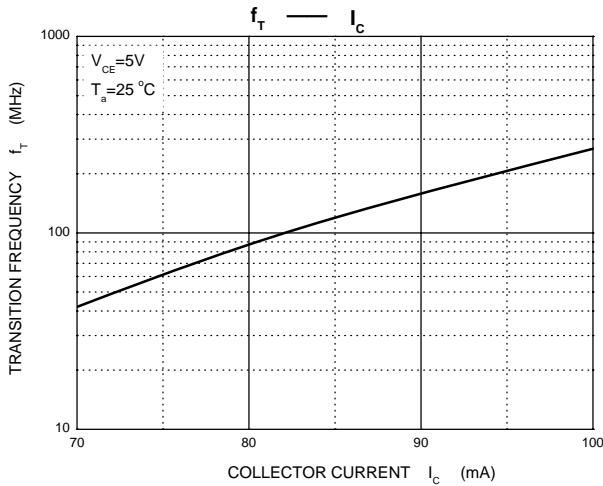
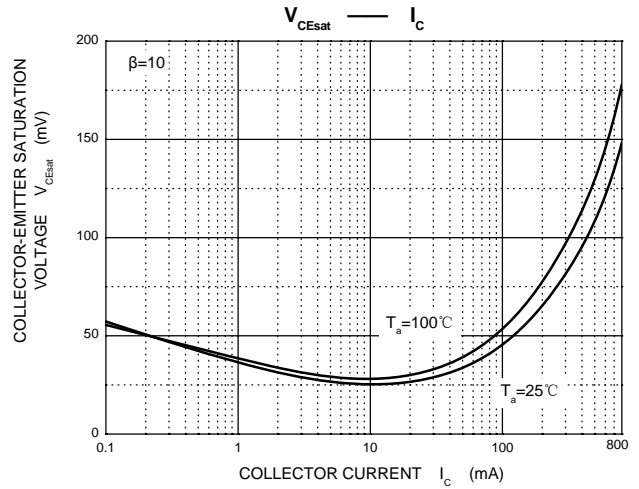
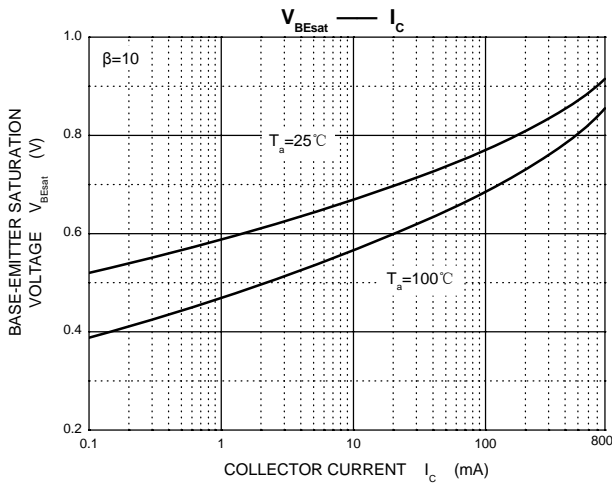
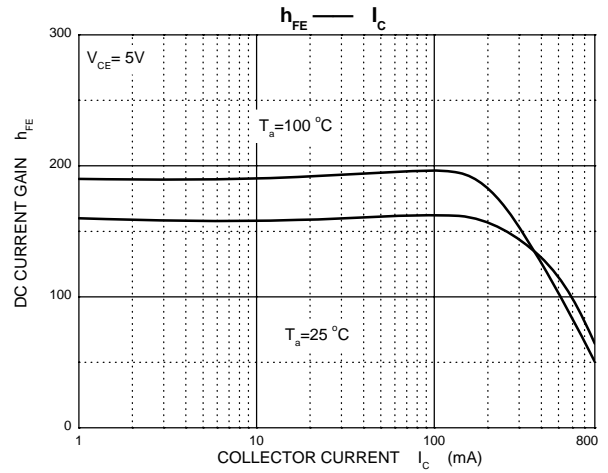
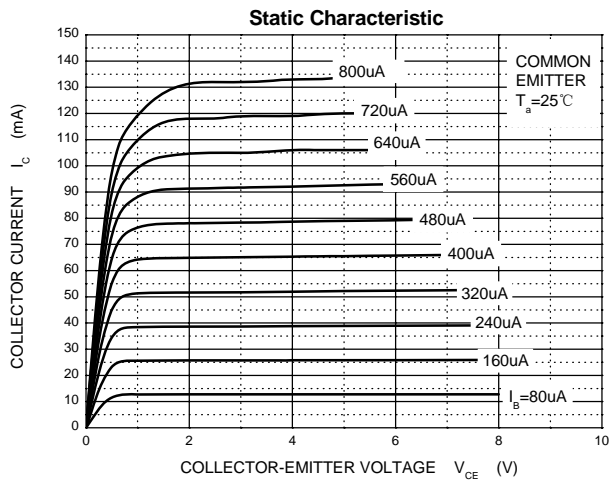

TO-92MOD Package Outline Dimensions

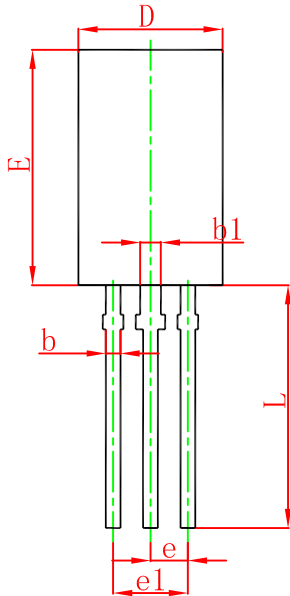
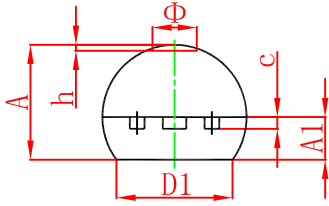

Symbol	Dimensions In Millimeters		Dimensions In Inches	
	Min.	Max.	Min.	Max.
A	4.800	5.000	0.189	0.197
A1	1.730	2.030	0.068	0.080
b	0.440	0.600	0.017	0.024
b1	0.940	1.100	0.037	0.043
c	0.350	0.450	0.014	0.018
D	5.900	6.100	0.232	0.240
D1	4.000		0.157	
E	8.500	8.700	0.335	0.343
e	1.500 TYP.		0.059 TYP.	
e1	2.900	3.100	0.114	0.122
L	13.800	14.200	0.543	0.559
Φ		1.600		0.063
h	0.000	0.380	0.000	0.015

TO-92MOD Suggested Pad Layout

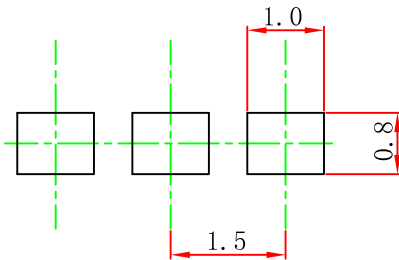

Note:

1. Controlling dimension: in millimeters.
2. General tolerance: ± 0.05 mm.
3. The pad layout is for reference purposes only.

NOTICE

JCET reserve the right to make modifications, enhancements, improvements, corrections or other changes without further notice to any product herein. JCET does not assume any liability arising out of the application or use of any product described herein.

TO-92MOD PACKAGE TAPEING DIMENSION

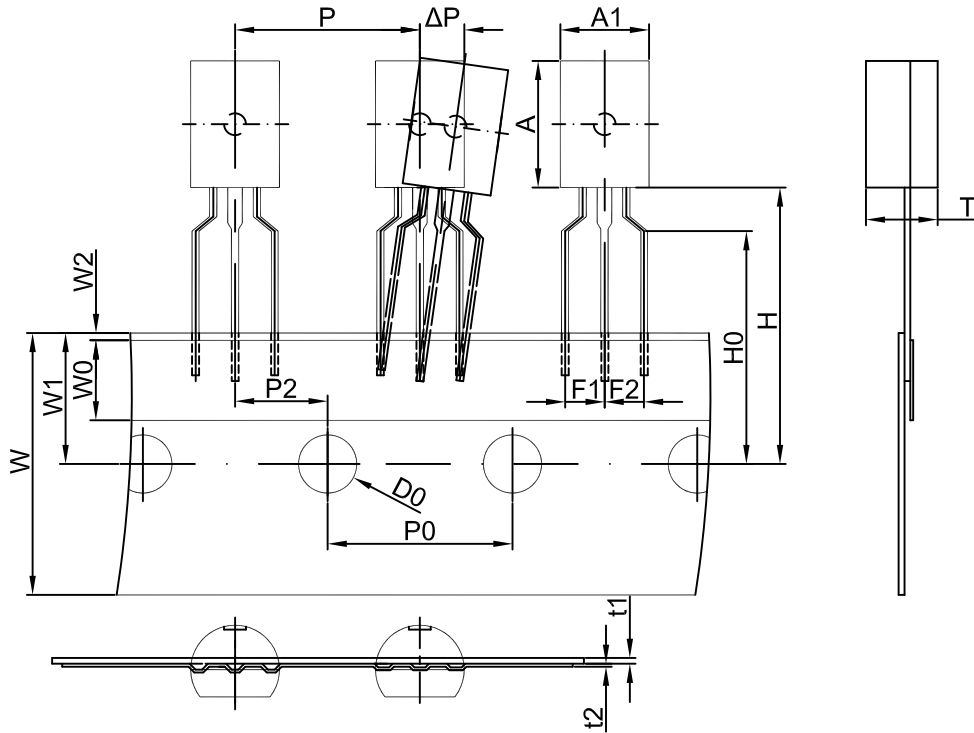

Dimensions are in millimeter

A1	A	T	P	P0	P2	F1	F2	W
6.0	8.6	4.9	12.7	12.7	6.35	2.5	2.5	18.0
W0	W1	W2	H	H0	D0	t1	t2	ΔP
6.0	9.0	1.0	19.0	16.0	4.0	0.4	0.2	0

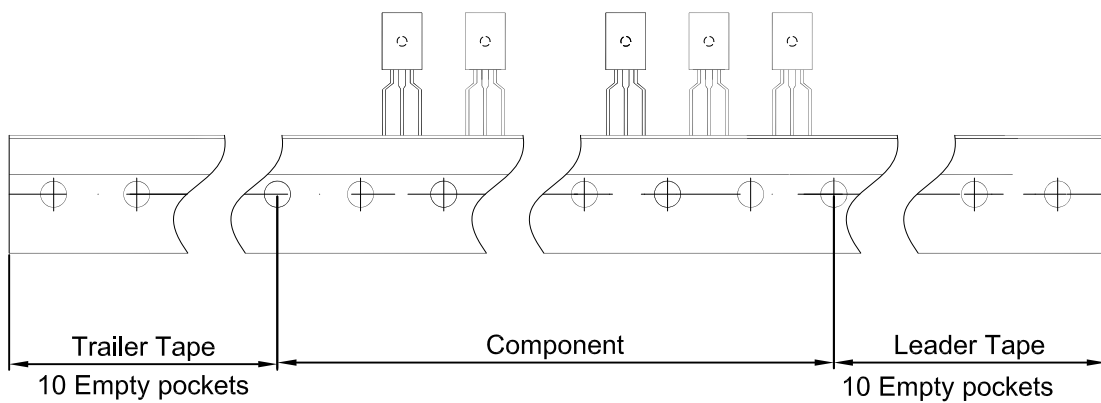

Package	Box	Box Size(mm)	Carton	Carton Size(mm)
TO-92MOD	2000 pcs	333×245×43	20,000 pcs	573×404×266