

TO-92 Plastic-Encapsulate Transistors

2SC1815 TRANSISTOR (NPN)

FEATURES

- Power dissipation

MAXIMUM RATINGS (T_a=25°C unless otherwise noted)

Symbol	Parameter	Value	Unit
V _{CB0}	Collector-Base Voltage	60	V
V _{CEO}	Collector-Emitter Voltage	50	V
V _{EBO}	Emitter-Base Voltage	5	V
I _C	Collector Current -Continuous	150	mA
P _C	Collector Power Dissipation	400	mW
R _{θJA}	Thermal Resistance from Junction to Ambient	312	°C/W
T _j	Junction Temperature	150	°C
T _{stg}	Storage Temperature	-55~+150	°C

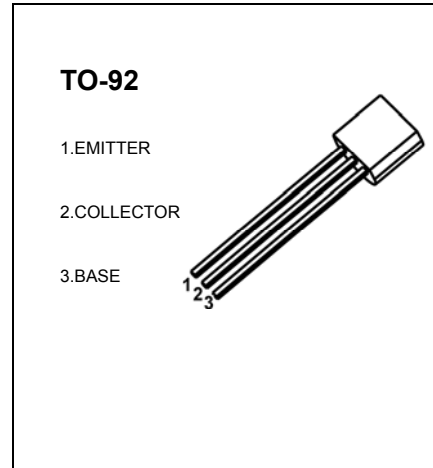

ELECTRICAL CHARACTERISTICS (T_a=25°C unless otherwise specified)

Parameter	Symbol	Test conditions	Min	Typ	Max	Unit
Collector-base breakdown voltage	V _{(BR)CBO}	I _C = 100uA, I _E =0	60			V
Collector-emitter breakdown voltage	V _{(BR)CEO}	I _C = 0. 1mA, I _B =0	50			V
Emitter-base breakdown voltage	V _{(BR)EBO}	I _E = 100uA, I _C =0	5			V
Collector cut-off current	I _{CB0}	V _{CB} = 60V, I _E =0			0.1	uA
Collector cut-off current	I _{CEO}	V _{CE} = 50V, I _B =0			0.1	uA
Emitter cut-off current	I _{EBO}	V _{EB} =5V, I _C =0			0.1	uA
DC current gain	h _{FE}	V _{CE} = 6 V, I _C = 2mA	70		700	
Collector-emitter saturation voltage	V _{CE(sat)}	I _C =100mA, I _B =10mA			0.25	V
Base-emitter saturation voltage	V _{BE(sat)}	I _C =100mA, I _B =10mA			1	V
Transition frequency	f _T	V _{CE} =10 V, I _C = 1mA f=30MHz	80			MHz
Collector Output Capacitance	C _{ob}	V _{CB} =10V, I _E =0 f=1MHz			3.5	pF
Noise Figure	NF	V _{CE} =6V, I _C =0.1mA f =1KHz, R _G =10K			10	dB

CLASSIFICATION OF h_{FE}

Rank	O	Y	GR	BL
Range	70-140	120-240	200-400	350-700

Typical Characteristics

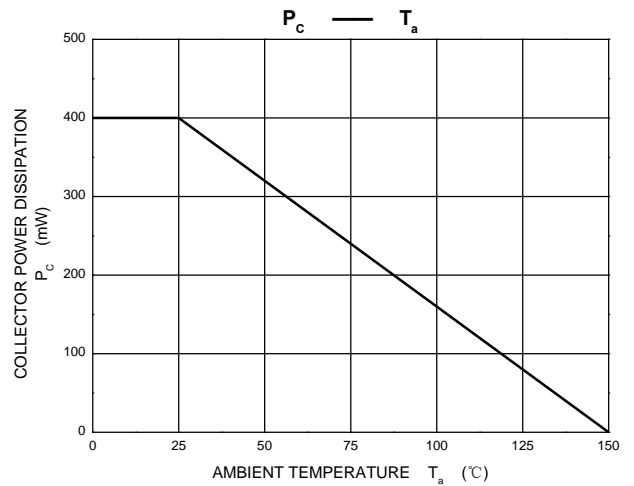
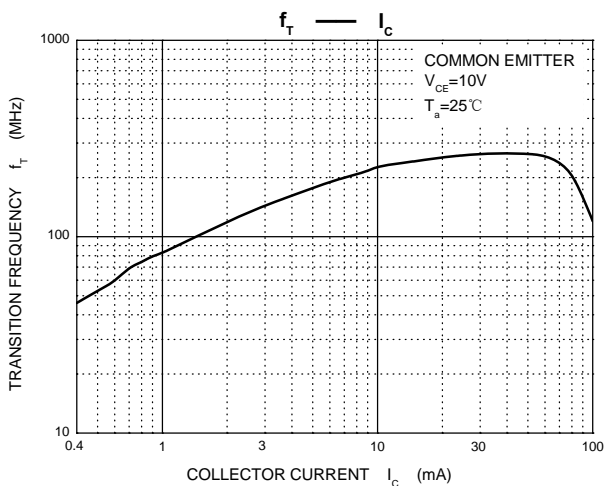
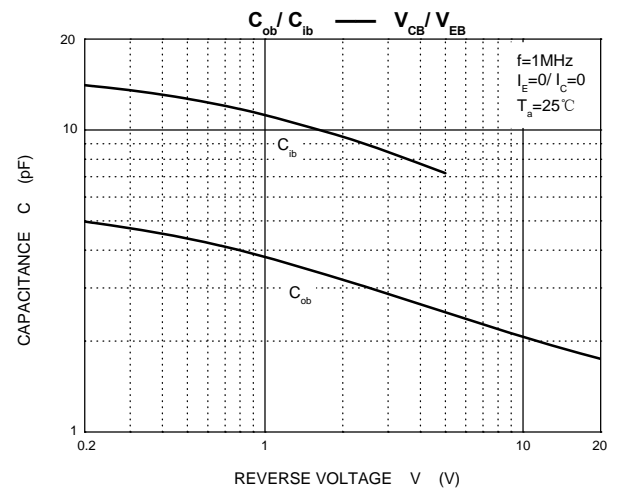
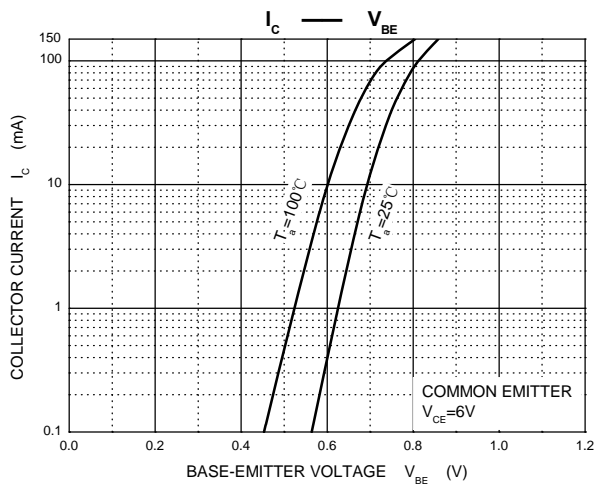
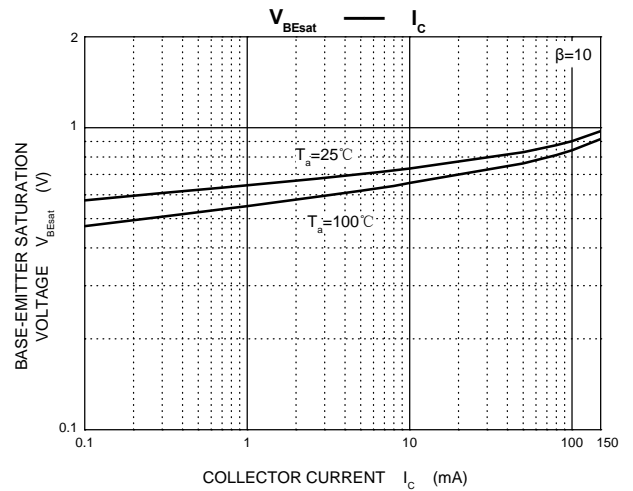
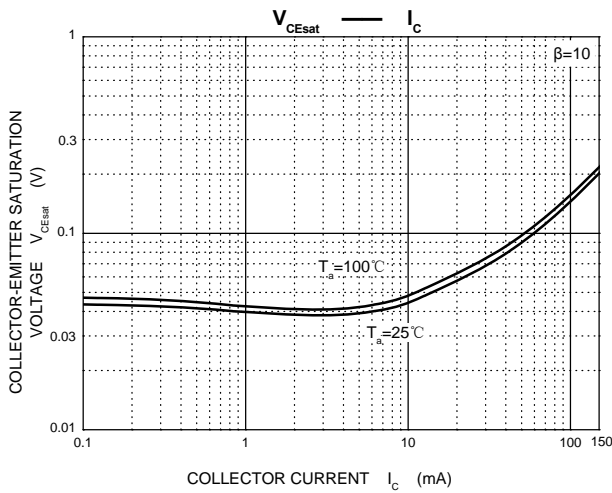
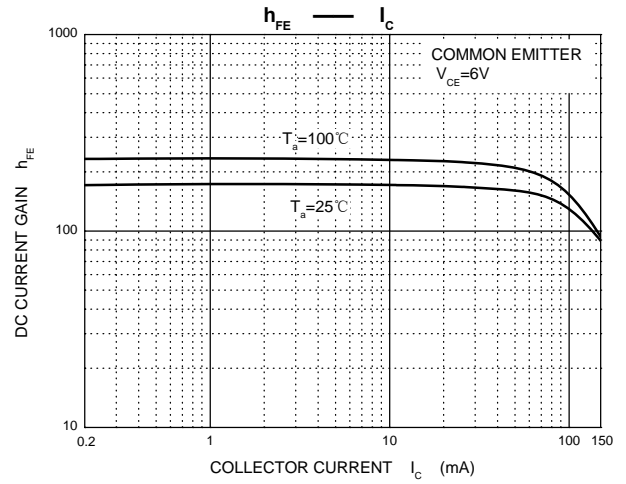
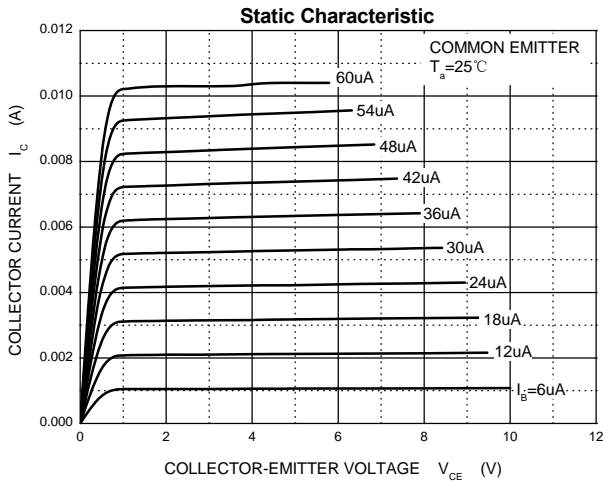

TO-92 Package Outline Dimensions



Symbol	Dimensions In Millimeters		Dimensions In Inches	
	Min	Max	Min	Max
A	3.300	3.700	0.130	0.146
A1	1.100	1.400	0.043	0.055
b	0.380	0.550	0.015	0.022
c	0.360	0.510	0.014	0.020
D	4.300	4.700	0.169	0.185
D1	3.430		0.135	
E	4.300	4.700	0.169	0.185
e	1.270 TYP		0.050 TYP	
e1	2.440	2.640	0.096	0.104
L	14.100	14.500	0.555	0.571
Φ		1.600		0.063
h	0.000	0.380	0.000	0.015

TO-92 Suggested Pad Layout



Note:

1. Controlling dimension: in millimeters.
2. General tolerance: $\pm 0.05\text{mm}$.
3. The pad layout is for reference purposes only.

NOTICE

JCET reserve the right to make modifications, enhancements, improvements, corrections or other changes without further notice to any product herein. JCET does not assume any liability arising out of the application or use of any product described herein.

TO-92 PACKAGE TAPEING DIMENSION



Dimiensions are in millimeter								
A1	A	T	P	P0	P2	F1	F2	W
4.5	4.5	3.5	12.7	12.7	6.35	2.5	2.5	18.0
W0	W1	W2	H	H0	D0	t1	t2	ΔP
6.0	9.0	1.0 MAX.	19.0	16.0	4.0	0.4	0.2	0



Package	Box	Box Size(mm)	Carton	Carton Size(mm)
TO-92	2000 pcs	333×162×43	20,000 pcs	350×340×250