

**TO-92MOD Plastic-Encapsulate Transistors**

**2SC1627A** TRANSISTOR (NPN)

**FEATURE**

- Complementary to 2SA817A
- Driver Stage Application of 30 to 35 Watts Amplifiers

**MAXIMUM RATINGS**( $T_a=25^{\circ}\text{C}$  unless otherwise noted)

Symbol	parameter	Value	Unit
$V_{CB0}$	Collector-Base Voltage	80	V
$V_{CE0}$	Collector-Emitter Voltage	80	V
$V_{EB0}$	Emitter-Base Voltage	5	V
$I_C$	Collector Current -Continuous	0.4	A
$P_C$	Collector Power Dissipation	0.8	W
$T_j$	Junction Temperature	150	$^{\circ}\text{C}$
$T_{stg}$	Storage Temperature Range	-55-150	$^{\circ}\text{C}$

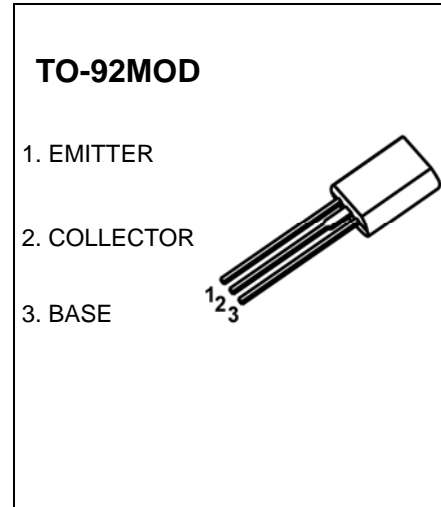

**ELECTRICAL CHARACTERISTICS** ( $T_a=25^{\circ}\text{C}$  unless otherwise specified)

Parameter	Symbol	Test conditions	Min	Typ	Max	Unit
Collector-base breakdown voltage	$V_{(BR)CB0}$	$I_C=100\mu\text{A}$ , $I_E=0$	80			V
Collector-emitter breakdown voltage	$V_{(BR)CE0}$	$I_C=5\text{mA}$ , $I_B=0$	80			V
Emitter-base breakdown voltage	$V_{(BR)EB0}$	$I_E=100\mu\text{A}$ , $I_C=0$	5			V
Collector cut-off current	$I_{CB0}$	$V_{CB}=50\text{V}$ , $I_E=0$			0.1	$\mu\text{A}$
Emitter cut-off current	$I_{EB0}$	$V_{EB}=5\text{V}$ , $I_C=0$			0.1	$\mu\text{A}$
DC current gain	$h_{FE(1)}$	$V_{CE}=2\text{V}$ , $I_C=50\text{mA}$	70		240	
	$h_{FE(2)}$	$V_{CE}=2\text{V}$ , $I_C=200\text{mA}$	40			
Collector-emitter saturation voltage	$V_{CE(sat)}$	$I_C=200\text{mA}$ , $I_B=20\text{mA}$			0.4	V
Base-emitter voltage	$V_{BE(on)}$	$V_{CE}=2\text{V}$ , $I_C=5\text{mA}$	0.55		0.8	V
Transition frequency	$f_T$	$V_{CE}=10\text{V}$ , $I_C=10\text{mA}$		100		MHz

**CLASSIFICATION OF  $h_{FE(1)}$**

Rank	O	Y
Range	70-140	120-240

# Typical Characteristics

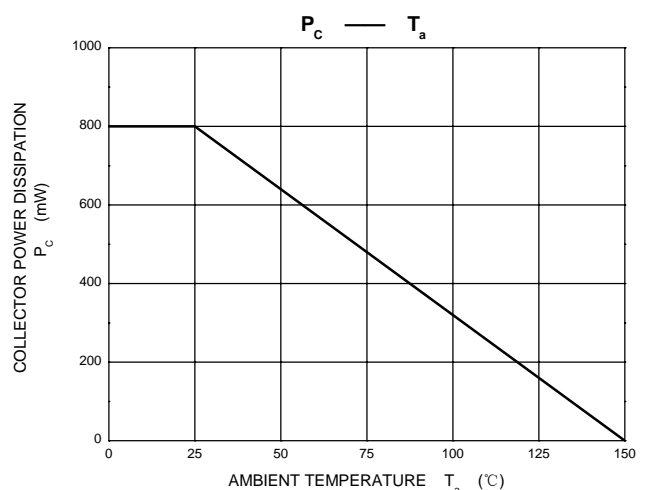
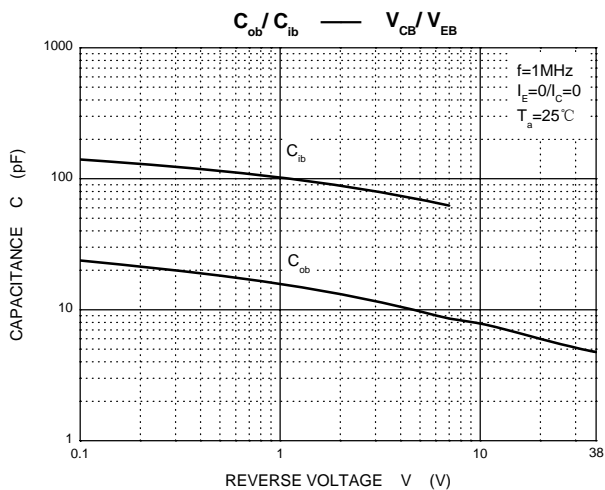
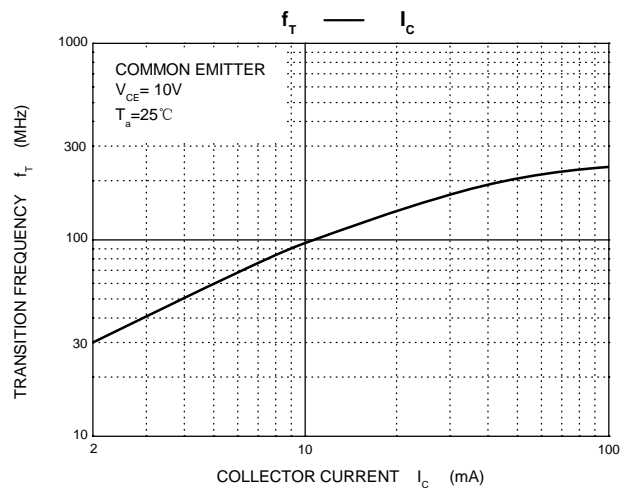
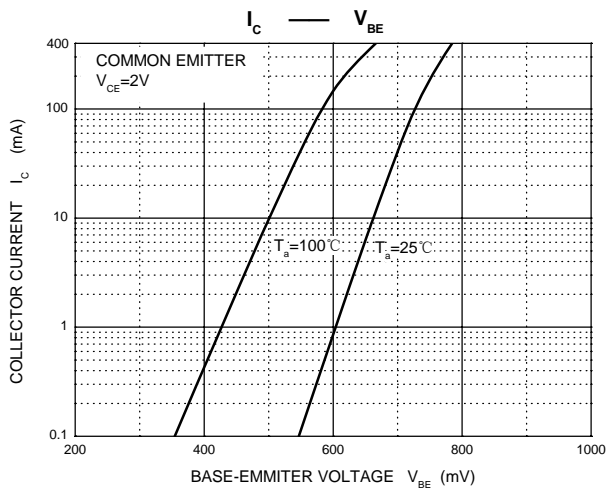
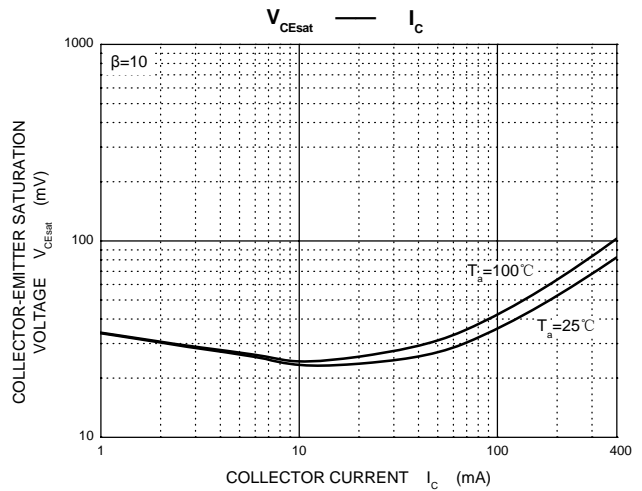
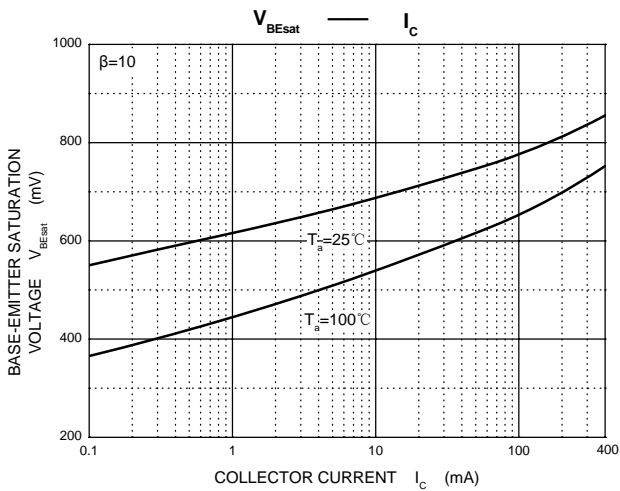
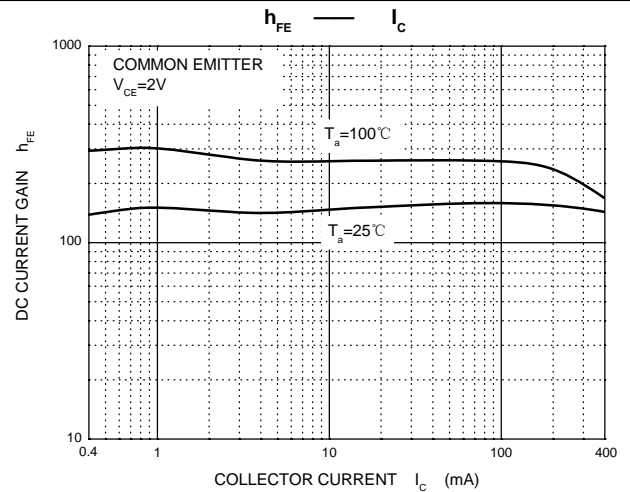
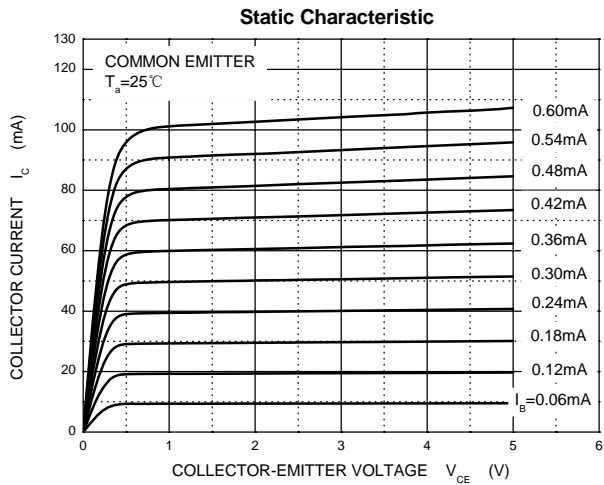

## TO-92MOD Package Outline Dimensions

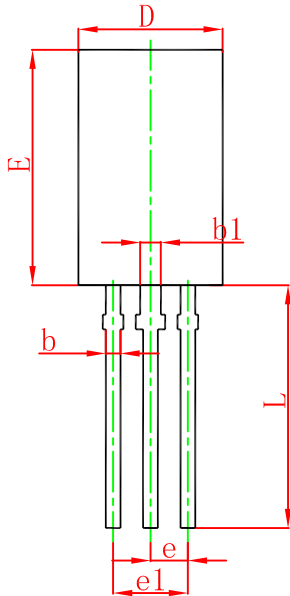
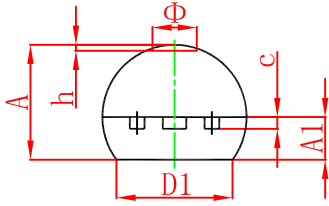

Symbol	Dimensions In Millimeters		Dimensions In Inches	
	Min.	Max.	Min.	Max.
A	4.800	5.000	0.189	0.197
A1	1.730	2.030	0.068	0.080
b	0.440	0.600	0.017	0.024
b1	0.940	1.100	0.037	0.043
c	0.350	0.450	0.014	0.018
D	5.900	6.100	0.232	0.240
D1	4.000		0.157	
E	8.500	8.700	0.335	0.343
e	1.500 TYP.		0.059 TYP.	
e1	2.900	3.100	0.114	0.122
L	13.800	14.200	0.543	0.559
$\Phi$		1.600		0.063
h	0.000	0.380	0.000	0.015

## TO-92MOD Suggested Pad Layout

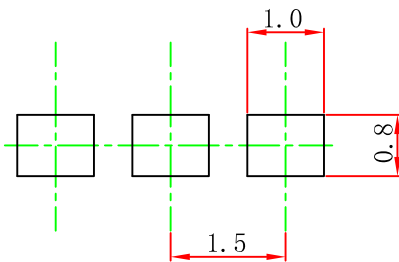

Note:

1. Controlling dimension: in millimeters.
2. General tolerance:  $\pm 0.05$ mm.
3. The pad layout is for reference purposes only.

### NOTICE

JCET reserve the right to make modifications, enhancements, improvements, corrections or other changes without further notice to any product herein. JCET does not assume any liability arising out of the application or use of any product described herein.

# TO-92MOD PACKAGE TAPEING DIMENSION

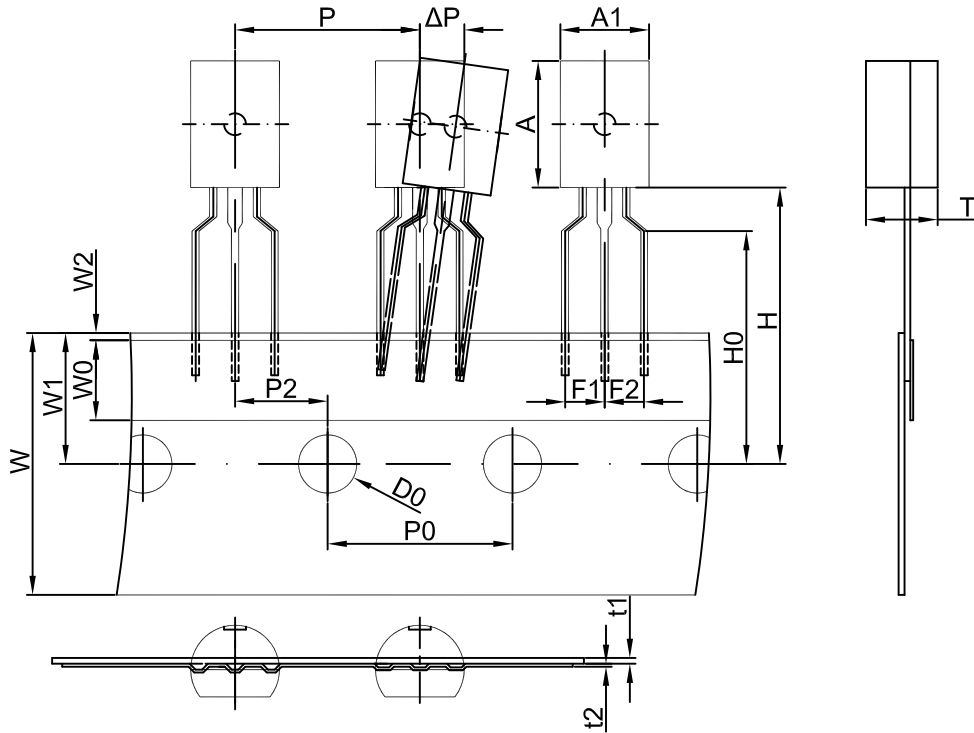

Dimensions are in millimeter

A1	A	T	P	P0	P2	F1	F2	W
6.0	8.6	4.9	12.7	12.7	6.35	2.5	2.5	18.0
W0	W1	W2	H	H0	D0	t1	t2	ΔP
6.0	9.0	1.0	19.0	16.0	4.0	0.4	0.2	0

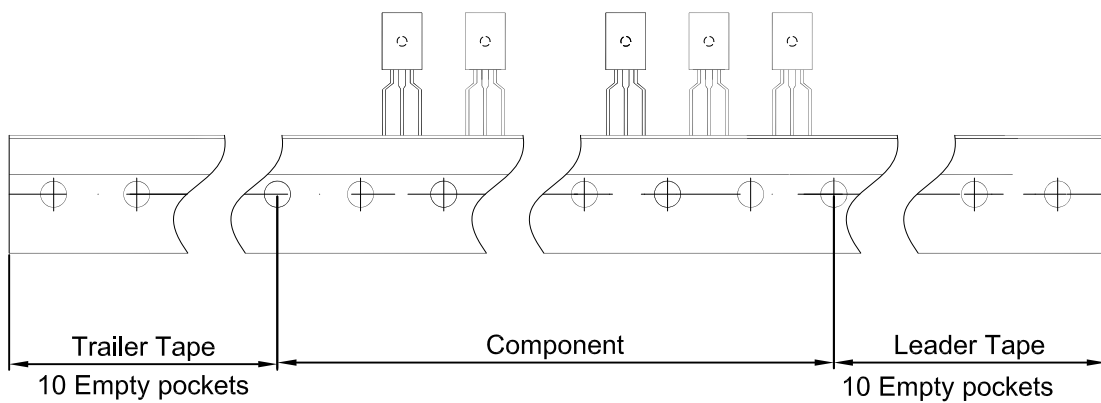

Package	Box	Box Size(mm)	Carton	Carton Size(mm)
TO-92MOD	2000 pcs	333×245×43	20,000 pcs	573×404×266