

TO-92MOD Plastic-Encapsulate Transistors

2SB764 TRANSISTOR (PNP)

FEATURES

- High Transition Frequency

TO – 92MOD

1. EMITTER
2. COLLECTOR
3. BASE

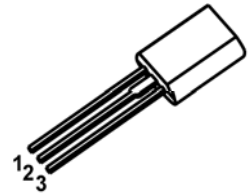

MARKING



B764=Device code
 Solid dot= Green molding compound device,
 if none, the normal device
 XXX=Code

Equivalent Circuit

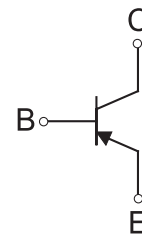

ORDERING INFORMATION

Part Number	Package	Packing Method	Pack Quantity
2SB764	TO-92MOD	Bulk	500pcs/Bag
2SB764-TA	TO-92MOD	Tape	2000pcs/Box

MAXIMUM RATINGS (T_a=25°C unless otherwise noted)

Symbol	Parameter	Value	Unit
V _{CBO}	Collector-Base Voltage	-60	V
V _{CEO}	Collector-Emitter Voltage	-50	V
V _{EBO}	Emitter-Base Voltage	-5	V
I _C	Collector Current	-1	A
P _C	Collector Power Dissipation	900	mW
R _{θJA}	Thermal Resistance From Junction To Ambient	139	°C/W
T _j	Junction Temperature	150	°C
T _{stg}	Storage Temperature	-55~+150	°C

ELECTRICAL CHARACTERISTICS

$T_a=25^\circ\text{C}$ unless otherwise specified

Parameter	Symbol	Test conditions	Min	Typ	Max	Unit
Collector-base breakdown voltage	$V_{(BR)CBO}$	$I_C = -10\mu\text{A}, I_E = 0$	-60			V
Collector-emitter breakdown voltage	$V_{(BR)CEO}$	$I_C = -1\text{mA}, I_B = 0$	-50			V
Emitter-base breakdown voltage	$V_{(BR)EBO}$	$I_E = -10\mu\text{A}, I_C = 0$	-5			V
Collector cut-off current	I_{CBO}	$V_{CB} = -50\text{V}, I_E = 0$			-1	μA
Emitter cut-off current	I_{EBO}	$V_{EB} = -4\text{V}, I_C = 0$			-1	μA
DC current gain	$h_{FE(1)}$	$V_{CE} = -2\text{V}, I_C = -50\text{mA}$	60		320	
	$h_{FE(2)}$	$V_{CE} = -2\text{V}, I_C = -1\text{A}$	30			
Collector-emitter saturation voltage	$V_{CE(sat)}$	$I_C = -500\text{mA}, I_B = -50\text{mA}$			-0.7	V
Base-emitter saturation voltage	$V_{BE(sat)}$	$I_C = -500\text{mA}, I_B = -50\text{mA}$			-1.2	V
Collector output capacitance	C_{ob}	$V_{CB} = -10\text{V}, I_E = 0, f = 1\text{MHz}$		20		pF
Transition frequency	f_T	$V_{CE} = -10\text{V}, I_C = -50\text{mA}$		150		MHz

CLASSIFICATION OF $h_{FE(1)}$

RANK	D	E	F
RANGE	60-120	100-200	160-320

TO-92MOD Package Outline Dimensions

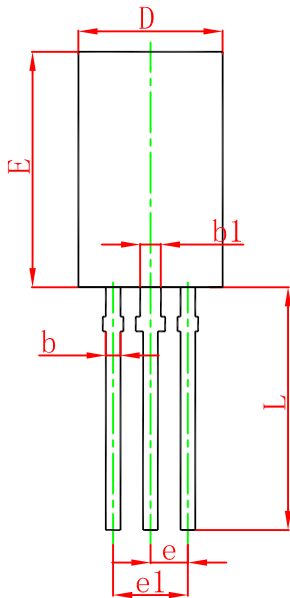
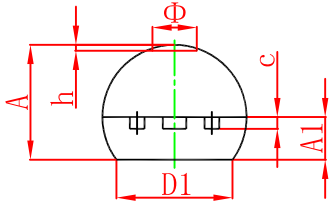

Symbol	Dimensions In Millimeters		Dimensions In Inches	
	Min.	Max.	Min.	Max.
A	4.800	5.000	0.189	0.197
A1	1.730	2.030	0.068	0.080
b	0.440	0.600	0.017	0.024
b1	0.940	1.100	0.037	0.043
c	0.350	0.450	0.014	0.018
D	5.900	6.100	0.232	0.240
D1	4.000		0.157	
E	8.500	8.700	0.335	0.343
e	1.500 TYP.		0.059 TYP.	
e1	2.900	3.100	0.114	0.122
L	13.800	14.200	0.543	0.559
Φ		1.600		0.063
h	0.000	0.380	0.000	0.015

TO-92MOD Suggested Pad Layout

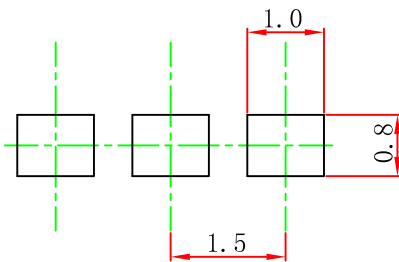

Note:

1. Controlling dimension: in millimeters.
2. General tolerance: ± 0.05 mm.
3. The pad layout is for reference purposes only.

NOTICE

JCET reserve the right to make modifications, enhancements, improvements, corrections or other changes without further notice to any product herein. JCET does not assume any liability arising out of the application or use of any product described herein.

TO-92MOD PACKAGE TAPEING DIMENSION

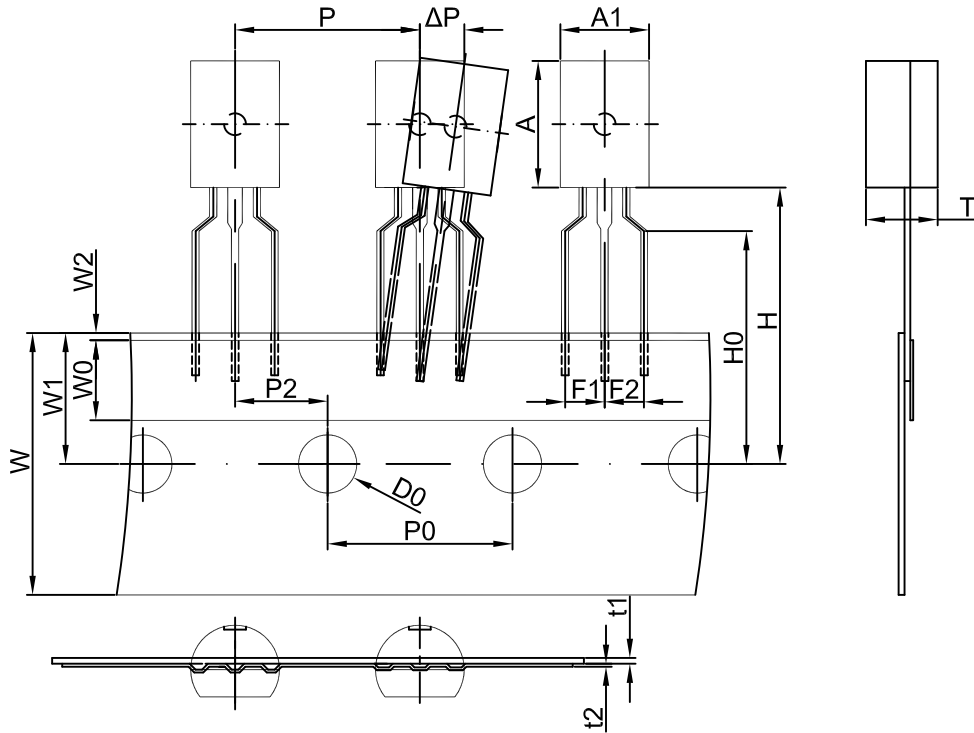

Dimensions are in millimeter

A1	A	T	P	P0	P2	F1	F2	W
6.0	8.6	4.9	12.7	12.7	6.35	2.5	2.5	18.0
W0	W1	W2	H	H0	D0	t1	t2	ΔP
6.0	9.0	1.0	19.0	16.0	4.0	0.4	0.2	0

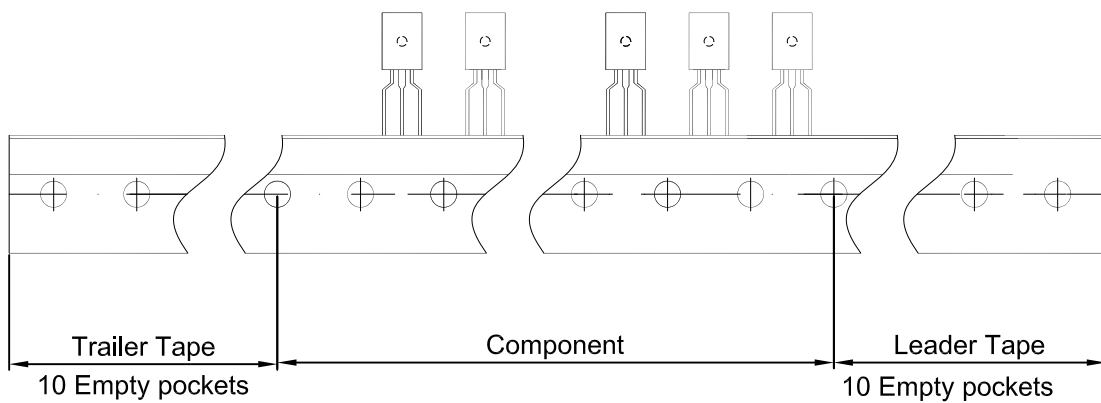

Package	Box	Box Size(mm)	Carton	Carton Size(mm)
TO-92MOD	2000 pcs	333×245×43	20,000 pcs	573×404×266