

## TO-92L Plastic-Encapsulate Transistors

### 2SB647 TRANSISTOR (PNP)

#### FEATURES

- Low Frequency Power Amplifier
- Complementary Pair with 2SD667

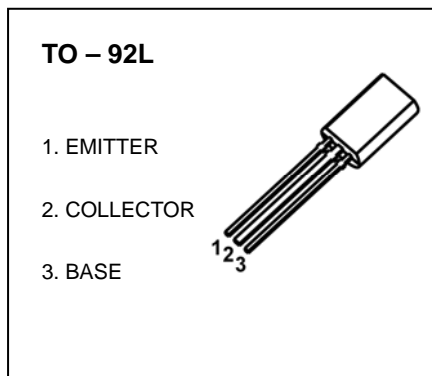

#### MARKING

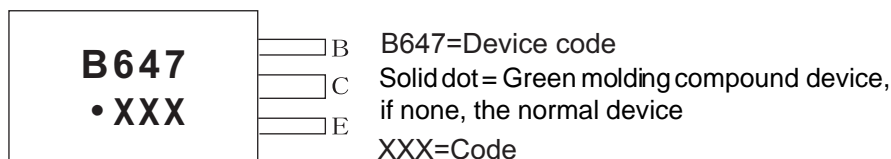

#### Equivalent Circuit

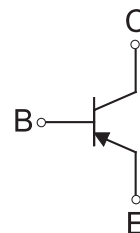

#### ORDERING INFORMATION

Part Number	Package	Packing Method	Pack Quantity
2SB647	TO-92L	Bulk	500pcs/Bag
2SB647-TA	TO-92L	Tape	2000pcs/Box

#### MAXIMUM RATINGS (T<sub>a</sub>=25°C unless otherwise noted)

Symbol	Parameter	Value	Unit
V <sub>CB0</sub>	Collector-Base Voltage	-120	V
V <sub>CE0</sub>	Collector-Emitter Voltage	-80	V
V <sub>EB0</sub>	Emitter-Base Voltage	-5	V
I <sub>C</sub>	Collector Current	-1	A
P <sub>C</sub>	Collector Power Dissipation	750	mW
R <sub>θJA</sub>	Thermal Resistance From Junction To Ambient	167	°C/W
T <sub>j</sub>	Junction Temperature	150	°C
T <sub>stg</sub>	Storage Temperature	-55~+150	°C

## ELECTRICAL CHARACTERISTICS

$T_a=25^\circ\text{C}$  unless otherwise specified

Parameter	Symbol	Test conditions	Min	Typ	Max	Unit
Collector-base breakdown voltage	$V_{(BR)CBO}$	$I_C=-10\mu\text{A}, I_E=0$	-120			V
Collector-emitter breakdown voltage	$V_{(BR)CEO}$	$I_C=-1\text{mA}, I_B=0$	-80			V
Emitter-base breakdown voltage	$V_{(BR)EBO}$	$I_E=-10\mu\text{A}, I_C=0$	-5			V
Collector cut-off current	$I_{CBO}$	$V_{CB}=-100\text{V}, I_E=0$			-10	$\mu\text{A}$
DC current gain	$h_{FE(1)}$ *	$V_{CE}=-5\text{V}, I_C=-150\text{mA}$	60		320	
	$h_{FE(2)}$ *	$V_{CE}=-5\text{V}, I_C=-500\text{mA}$	30			
Collector-emitter saturation voltage	$V_{CE(sat)}$ *	$I_C=-500\text{mA}, I_B=-50\text{mA}$			-1	V
Base-emitter voltage	$V_{BE}$ *	$V_{CE}=-5\text{V}, I_C=-150\text{mA}$			-1.5	V
Collector output capacitance	$C_{ob}$	$V_{CB}=-10\text{V}, I_E=0, f=1\text{MHz}$		20		pF
Transition frequency	$f_T$	$V_{CE}=-5\text{V}, I_C=-150\text{mA}$		140		MHz

\*Pulse test

### CLASSIFICATION OF $h_{FE(1)}$

RANK	B	C	D
RANGE	60-120	100-200	160-320

# Typical Characteristics

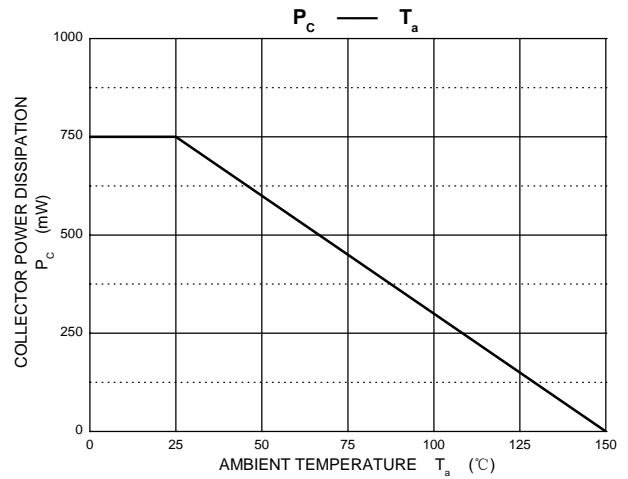
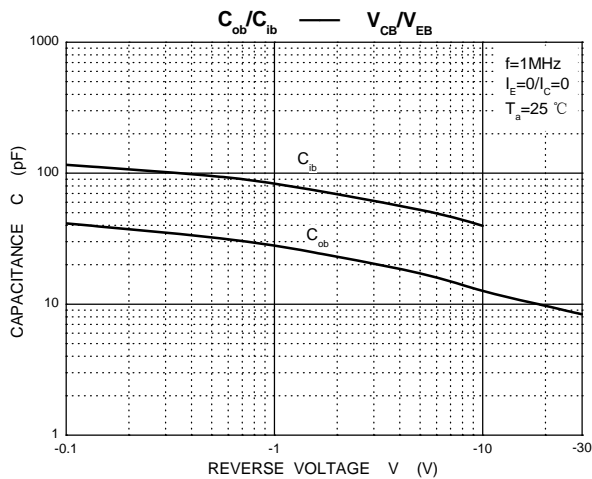
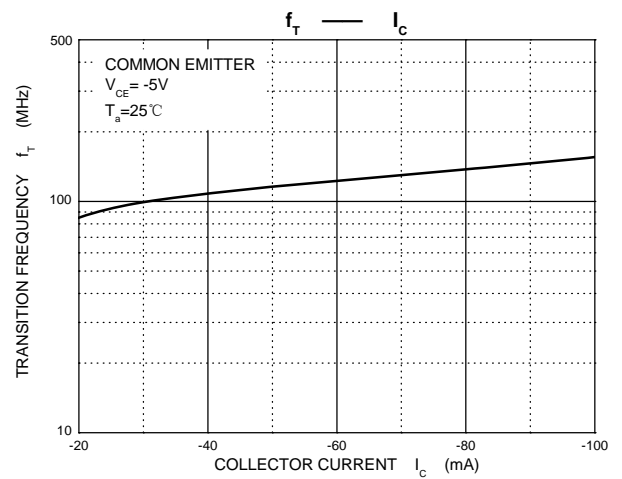
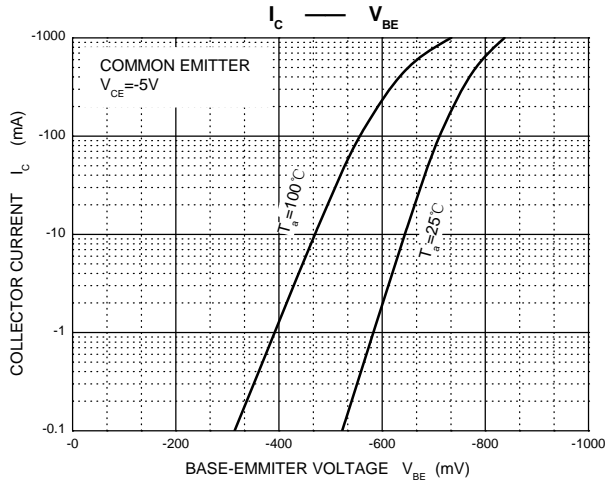
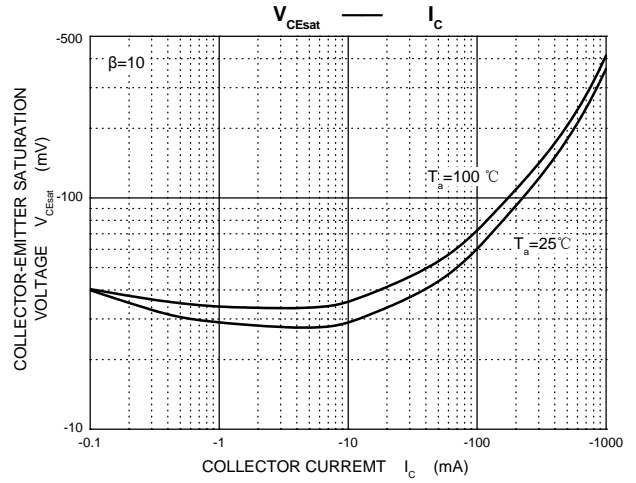
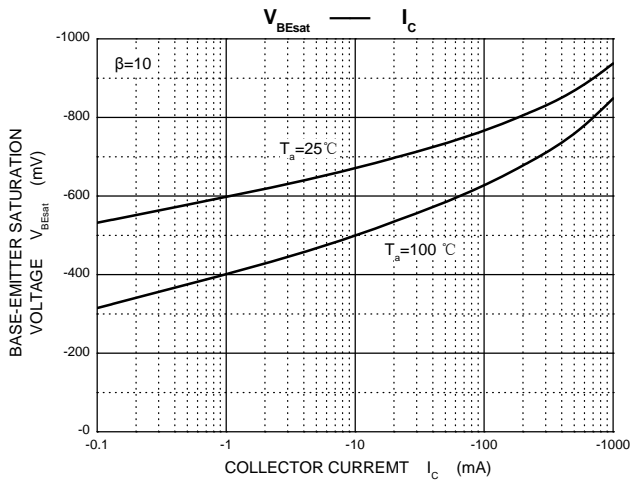
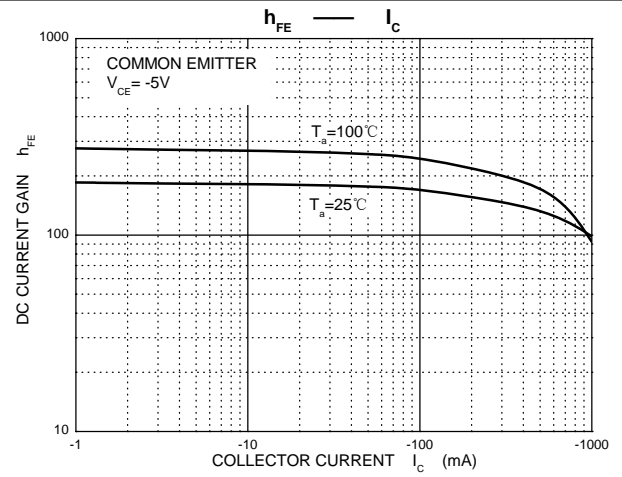
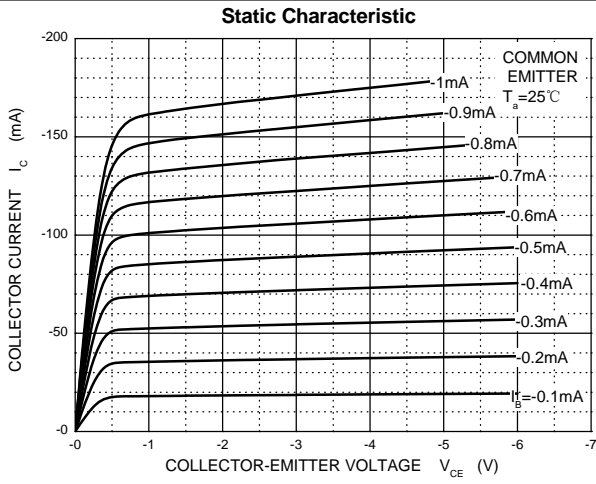

## TO-92L Package Outline Dimensions

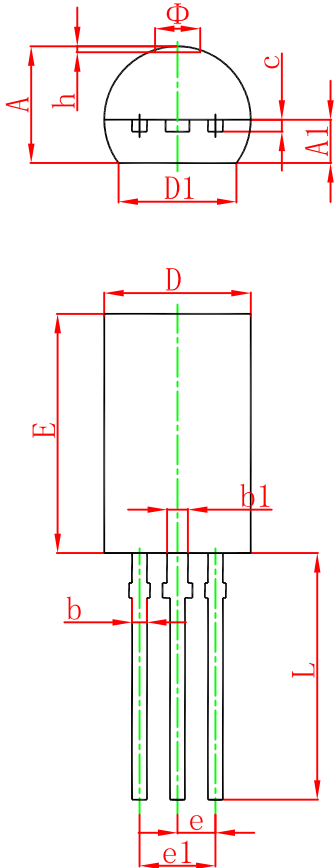

Symbol	Dimensions In Millimeters		Dimensions In Inches	
	Min.	Max.	Min.	Max.
A	3.750	4.050	0.148	0.159
A1	1.280	1.580	0.050	0.062
b	0.380	0.550	0.015	0.022
b1	0.620	0.780	0.024	0.031
c	0.350	0.450	0.014	0.018
D	4.750	5.050	0.187	0.199
D1	4.000		0.157	
E	7.850	8.150	0.309	0.321
e	1.270 TYP.		0.050 TYP.	
e1	2.440	2.640	0.096	0.104
L	13.800	14.200	0.543	0.559
$\Phi$		1.600		0.063
h	0.000	0.300	0.000	0.012

## TO-92L Suggested Pad Layout

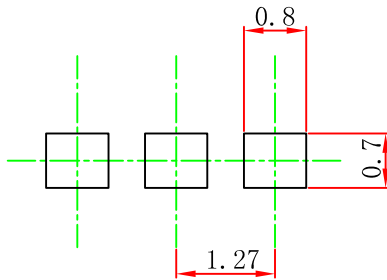

### Note:

1. Controlling dimension: in millimeters.
2. General tolerance:  $\pm 0.05\text{mm}$ .
3. The pad layout is for reference purposes only.

### NOTICE

JCET reserve the right to make modifications, enhancements, improvements, corrections or other changes without further notice to any product herein. JCET does not assume any liability arising out of the application or use of any product described herein.

# TO-92L PACKAGE TAPEING DIMENSION

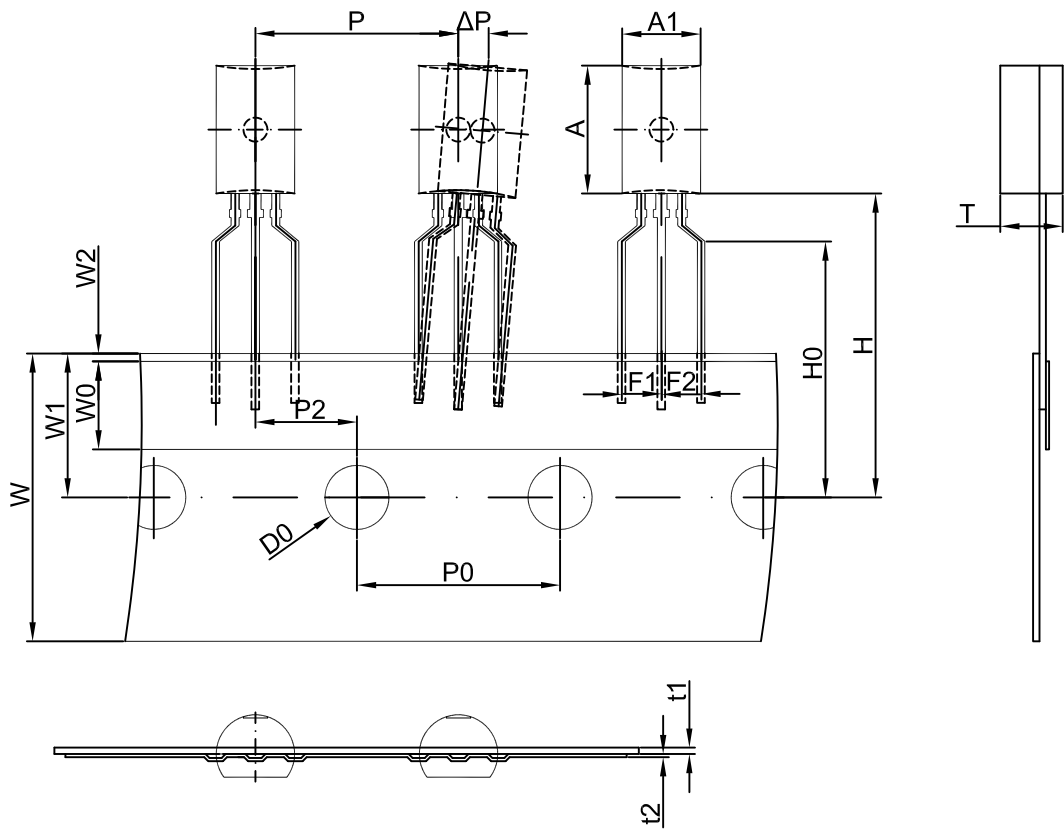

Dimensions are in millimeter

A1	A	T	P	P0	P2	F1	F2	W
4.9	8.0	3.9	12.7	12.7	6.35	2.5	2.5	18.0
W0	W1	W2	H	H0	D0	t1	t2	$\Delta P$
6.0	9.0	1.0	19.0	16.0	4.0	0.4	0.2	0

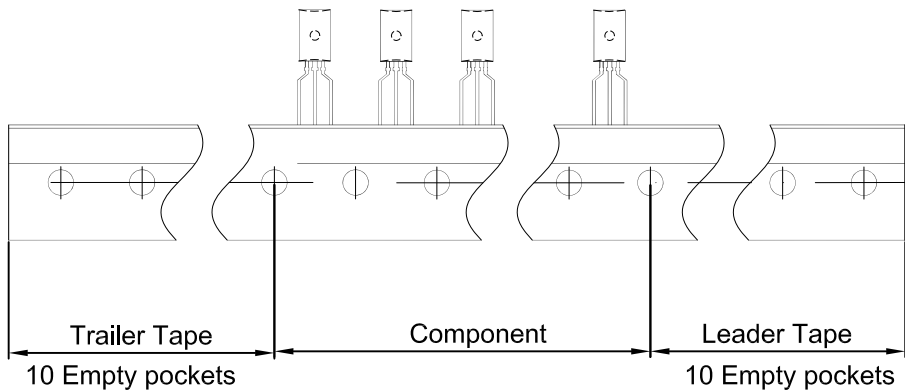

Package	Box	Box Size(mm)	Carton	Carton Size(mm)
TO-92L	2000 pcs	333×203×42	20,000 pcs	493×400×264