

## TO-92S Plastic-Encapsulate Transistors

### 2SA1048 TRANSISTOR (PNP)

#### FEATURES

- High voltage
- High  $h_{FE}$
- Low noise
- Complementary to 2SC2458

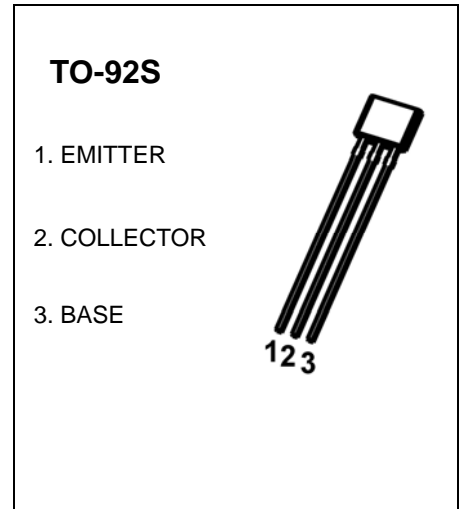

#### MARKING

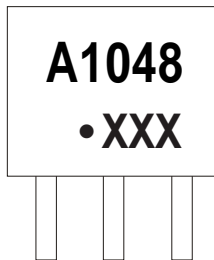

A1048=Device code  
 Solid dot= Green molding compound device,  
 if none, the normal device  
 XXX=Code

#### Equivalent Circuit

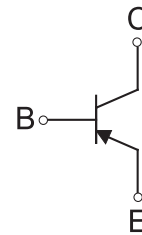

#### ORDERING INFORMATION

Part Number	Package	Packing Method	Pack Quantity
2SA1048	TO-92S	Bulk	1000pcs/Bag
2SA1048-TA	TO-92S	Tape	3000pcs/Box

#### MAXIMUM RATINGS ( $T_a=25^{\circ}\text{C}$ unless otherwise noted)

Symbol	Parameter	Value	Unit
$V_{CBO}$	Collector- Base Voltage	-50	V
$V_{CEO}$	Collector-Emitter Voltage	-50	V
$V_{EBO}$	Emitter-Base Voltage	-5	V
$I_c$	Collector Current -Continuous	-0.15	A
$P_C$	Collector Power Dissipation	0.2	W
$T_J$	Junction Temperature	150	$^{\circ}\text{C}$
$T_{stg}$	Storage Temperature	-55-150	$^{\circ}\text{C}$

## ELECTRICAL CHARACTERISTICS

$T_a=25^\circ\text{C}$  unless otherwise specified

Parameter	Symbol	Test conditions	Min	Typ	Max	Unit
Collector-base breakdown voltage	$V_{(BR)CBO}$	$I_C=-100\ \mu\text{A}, I_E=0$	-50			V
Collector-emitter breakdown voltage	$V_{(BR)CEO}$	$I_C=-1\text{mA}, I_B=0$	-50			V
Emitter-base breakdown voltage	$V_{(BR)EBO}$	$I_E=-100\ \mu\text{A}, I_C=0$	-5			V
Collector cut-off current	$I_{CBO}$	$V_{CB}=-50\ \text{V}, I_E=0$			-0.1	$\mu\text{A}$
Emitter cut-off current	$I_{EBO}$	$V_{EB}=-5\ \text{V}, I_C=0$			-0.1	$\mu\text{A}$
DC current gain	$h_{FE}$	$V_{CE}=-6\ \text{V}, I_C=-2\text{mA}$	70		400	
Collector-emitter saturation voltage	$V_{CE(sat)}$	$I_C=-100\text{mA}, I_B=-10\text{mA}$			-0.3	V
Transition frequency	$f_T$	$V_{CE}=-10\ \text{V}, I_C=-1\text{mA}$	80			MHz
Collector output capacitance	$C_{ob}$	$V_{CB}=-10\ \text{V}, I_E=0, f=1\ \text{MHz}$			7	pF
Noise figure	NF	$V_{CE}=-6\ \text{V}, I_C=-0.1\ \text{mA},$ $f=1\ \text{KHz}, R_g=10\ \text{K}\Omega$			10	dB

### CLASSIFICATION OF $h_{FE}$

Rank	O	Y	GR
Range	70-140	120-240	200-400

# Typical Characteristics

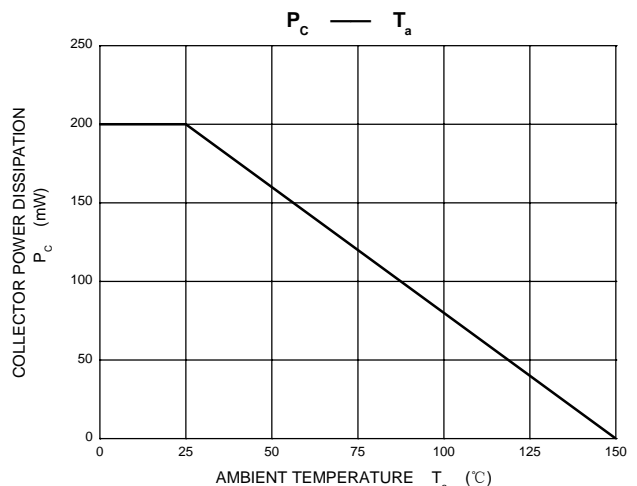
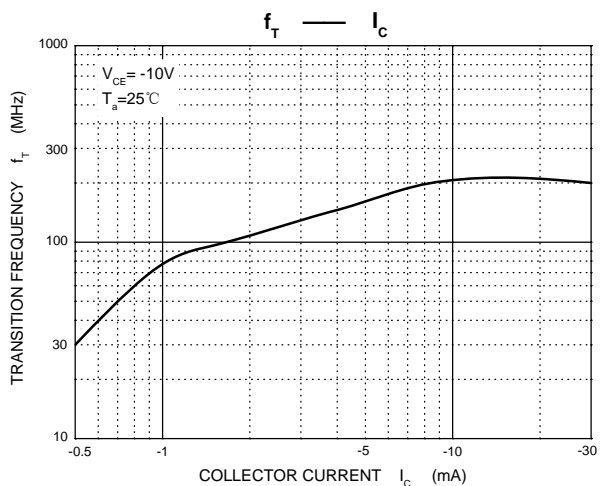
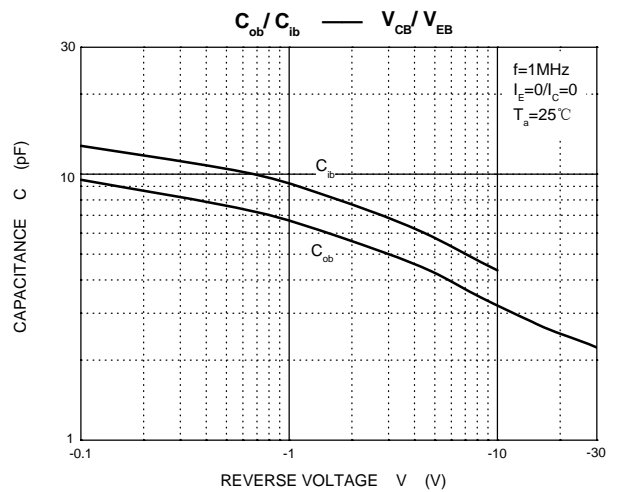
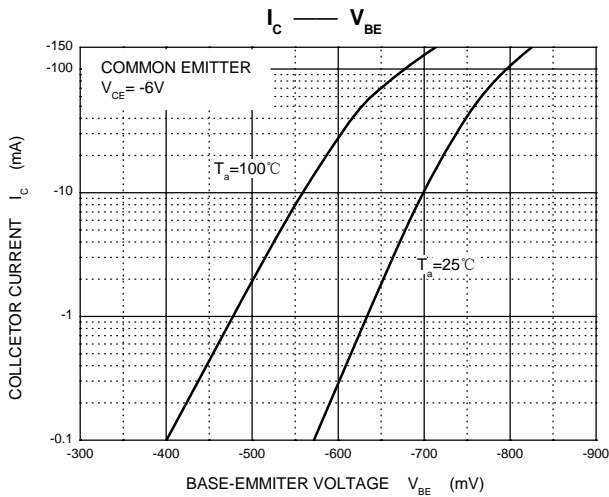
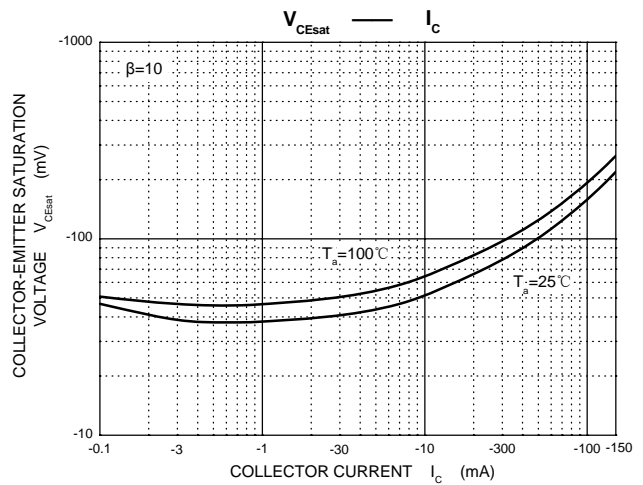
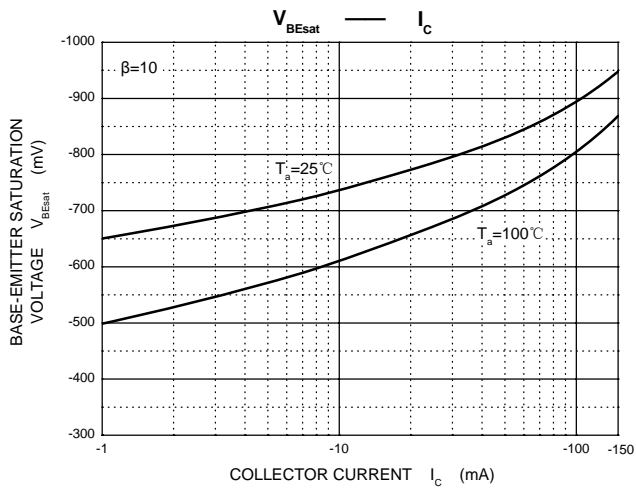
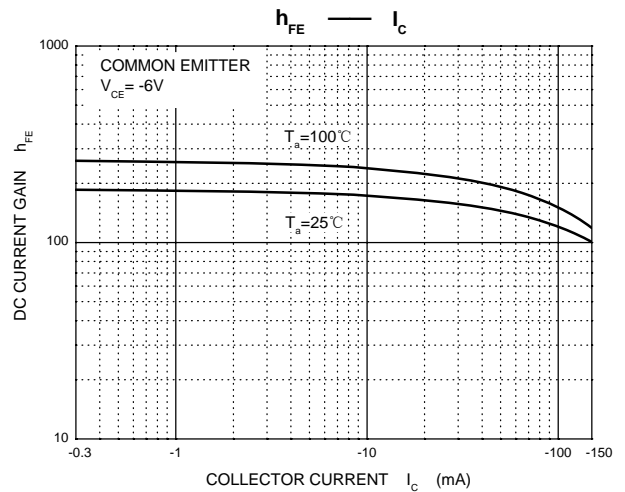
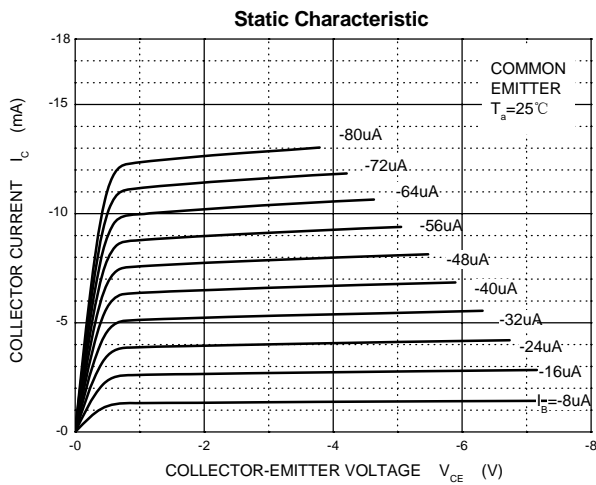

## TO-92S Package Outline Dimensions

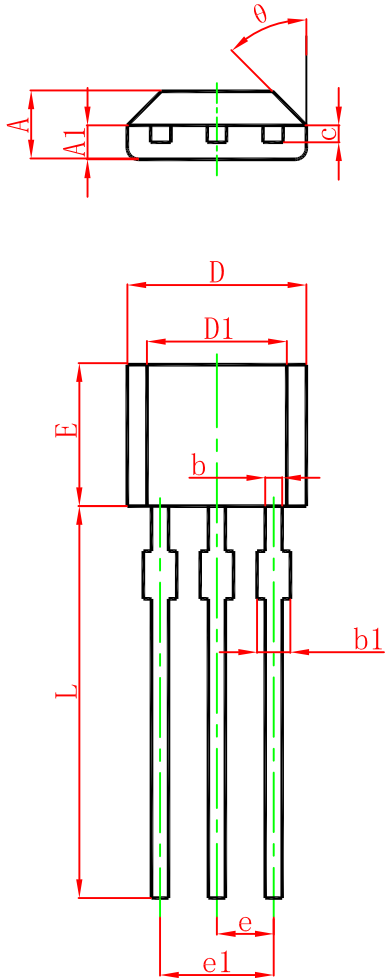

Symbol	Dimensions In Millimeters		Dimensions In Inches	
	Min.	Max.	Min.	Max.
A	1.420	1.620	0.056	0.064
A1	0.660	0.860	0.026	0.034
b	0.330	0.480	0.013	0.019
b1	0.400	0.510	0.016	0.020
c	0.330	0.510	0.013	0.020
D	3.900	4.100	0.154	0.161
D1	2.280	2.680	0.090	0.106
E	3.050	3.250	0.120	0.128
e	1.270 TYP.		0.050 TYP.	
e1	2.440	2.640	0.096	0.104
L	15.100	15.500	0.594	0.610
θ	45° TYP.		45° TYP.	

## TO-92S Suggested Pad Layout

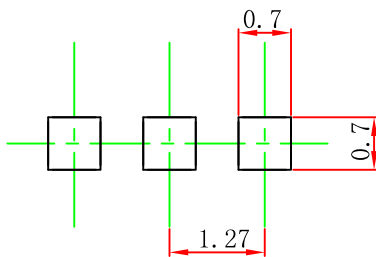

Note:

1. Controlling dimension: in millimeters.
2. General tolerance:  $\pm 0.05$  mm.
3. The pad layout is for reference purposes only.

### NOTICE

JCET reserve the right to make modifications, enhancements, improvements, corrections or other changes without further notice to any product herein. JCET does not assume any liability arising out of the application or use of any product described herein.

# TO-92S PACKAGE TAPEING DIMENSION

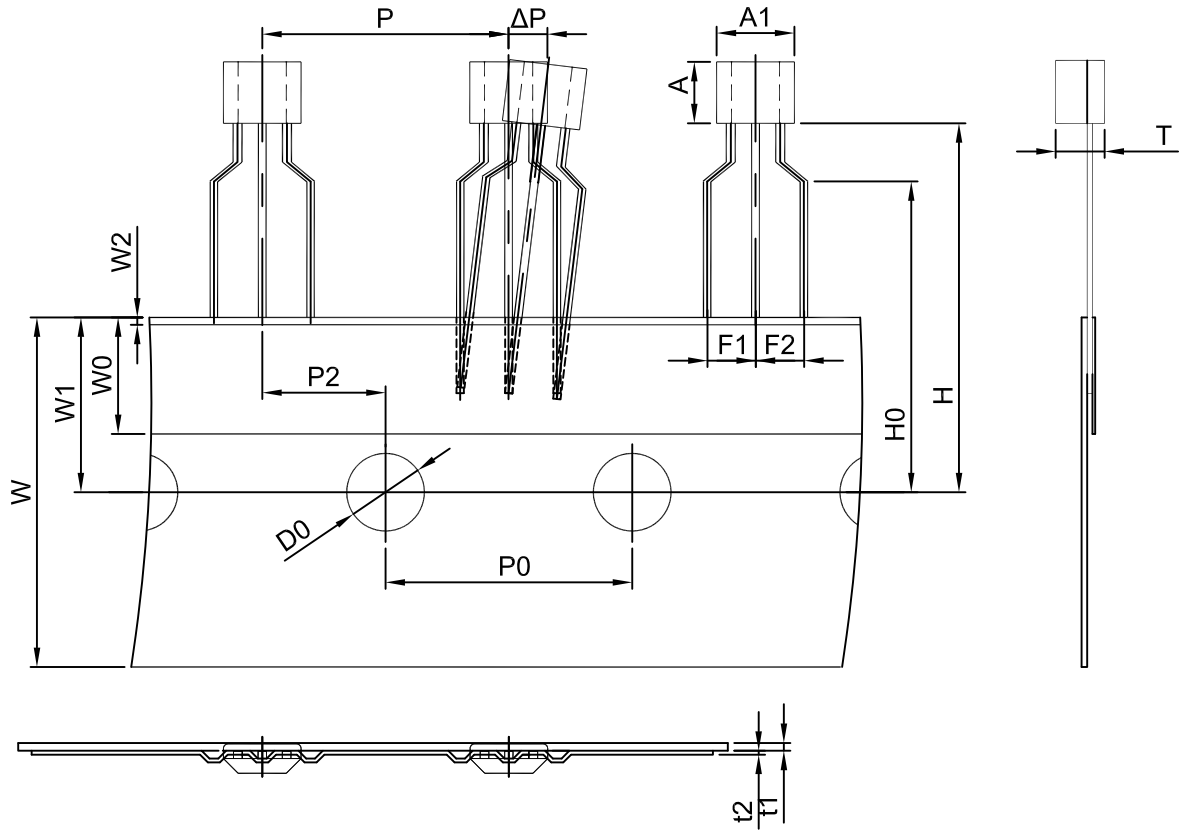

Dimiensions are in millimeter

A1	A	T	P	P0	P2	F1	F2	W
4.0	3.15	1.52	12.7	12.7	6.35	2.5	2.5	18.0
W0	W1	W2	H	H0	D0	t1	t2	ΔP
6.0	9.0	1.0	19.0	16.0	4.0	0.4	0.2	0

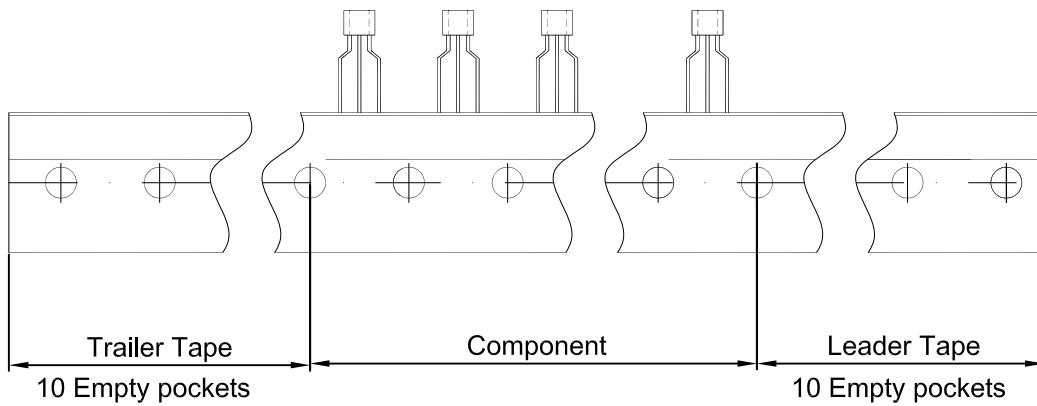

Package	Box	Box Size(mm)	Carton	Carton Size(mm)
TO-92S	3000 pcs	333×162×43	30,000 pcs	350×340×250